

HITACHI

SERVICE MANUAL

TY

No. 505 EGF

HTA-D50(US,CS,SA,KS,VS,
BS,ZS,EW,ES)

HTA-D30(US,CS,SA,KS,VS,
BS,ZS,EW,ES)

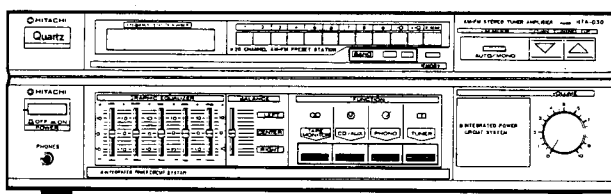
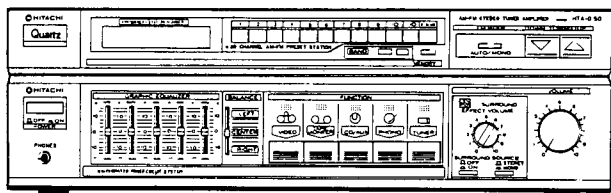

HTA-D50

HTA-D30

CONTENTS

SPECIFICATIONS	2
CIRCUIT BOARD CHECKING AND FRONT PANEL ASS'Y DISASSEMBLY PROCEDURES	5
GENERAL ALIGNMENT INSTRUCTION	6-8
CIRCUIT DIAGRAM	9-12, 15
PRINTED WIRING BOARD	13, 14
FRONT AND REAR PANEL	16, 17
BLOCK DIAGRAM	18
REPLACEMENT PARTS LIST	19-23

INHALT

TECHNISCHE DATEN	3
PRÜFUNG DER LEITERPLATTE UND VORDERE BEDIENUNGSTAFEL-DEMONTAGEVORGÄNGE	5
ALLGEMEINE AUSRICHTANLEITUNG	6-8
SCHALTPLAN	9-12, 15
PRINTPLATTEN	13, 14
VORDERE UND HINTER BEDIENUNGSTAFEL	16, 17
BLOCKSCHEMA	18
ERSATZTEILLISTE	19-23

SOMMAIRE

CARACTERISTIQUES TECHNIQUES	4
CONTROLE DE CARTE A CIRCUITSIM-PRIMES ET PANEAU AVANT DE DEMONTAGE DE PLAQUE DECORTIVE	5
INSTRUCTIONS GMERLESS	6-8
PLAN DE CIRCUIT	9-12, 15
PLAN DE BASE	13, 14
PANNEAUX AVANT ET ARRIERE	16, 17
HEMA	18
TABLEAU DE PIECES	19-23

SAFETY PRECAUTION

The following precautions should be observed when servicing.

1. Since many parts in the unit have special safety related characteristics, always use genuine Hitachi's replacement parts. Especially critical parts in the power circuit block should not be replaced with other makers.
Critical parts are marked with Δ in the circuit diagram and printed wiring board.
2. Before returning a repaired unit to the customer, the service technician must thoroughly test the unit to ascertain that it is completely safe to operate without danger of electrical shock.

SICHERHEITSMASSNAHMEN

Bei Wartungsarbeiten sind die folgenden Sicherheitsmaßnahmen zu beachten:

1. Da verschiedene Teile dieses Gerätes Sicherheitsfunktionen aufweisen, nur Original-Hitachi-Ersatzteile verwenden. Kritische Teile im Netzteil sollten nicht durch ähnliche Teil anderer Hersteller ersetzt werden. Alle kritischen Teil sind im Schaltplan und im Diagramm der Schaltplatinen mit dem Symbol Δ gekennzeichnete.
2. Vor der Auslieferung eines reparierten Gerätes an den Kunden muß der Wartungstechniker das Gerät einer gründlichen Prüfung unterziehen, um sicherzustellen, daß sicherer Betrieb ohne die Gefahr von elektrischen Schlägen gewährleistet ist.

PRÉCAUTIONS DE SÉCURITÉ

Les précautions suivantes doivent être observées chaque fois qu'une réparation doit être faite.

1. Etant donné que de nombreux composants de l'appareil possèdent des caractéristiques relatives à la sécurité, utiliser uniquement des pièces de rechange d'origine Hitachi pour effectuer un remplacement des du bloc d'alimentation qui ne doivent en aucun cas être remplacées par celles d'autres fabricants. Les pièces critiques sont accompagnés du symbole Δ dans le schéma de montage et sur le schéma de plaque de câblage.
2. Avant de retourner l'appareil réparé au client le technicien doit procéder à un essai complet pour s'assurer qu'il ne présente aucun danger chocs électriques.

SPECIFICATIONS AND PARTS ARE SUBJECT TO CHANGE FOR IMPROVEMENT.

STEREO TUNER AMPLIFIER

August 1986

TOYOKAWA WORKS

SPECIFICATIONS

● **FM SECTION**

Frequency range 87.9 – 107.9 MHz (100 kHz spacing)
[for US, CS]
87.50 – 108.00 MHz (50 kHz spacing) [except US, CS]

Usable sensitivity (Mono) 13.7 dBf (IHF)
1.5 μ V (IEC)

Signal-to-noise ratio Mono: 69 dB (IHF)
Stereo: 67 dB (IHF) [HTA-D50]
Mono: 60 dB (DIN Audio Q-Peak)
60 dB (DIN Noise Q-Peak)
Stereo: 58 dB (DIN Audio Q-Peak)
58 dB (DIN Noise Q-Peak)

Total harmonic distortion (1 kHz, at 65 dBf) Mono: 0.4%
Stereo: 0.6%

Frequency response Selectivity 30 Hz – 12 kHz \pm 2.5 dB
60 dB (\pm 300 kHz)
65dB (\pm 400 kHz)

Stereo separation (1 kHz) 40 dB

Antenna input 75 ohms unbalanced

● **MW SECTION**

Frequency range 522 – 1,611 kHz (9 kHz spacing)
[except US, CS]
530 – 1620 kHz (10 kHz spacing)
[for US, CS]

Sensitivity 40 μ V (IHF, ext antenna)
80 μ V (IEC, ext antenna)

Selectivity 35 dB

Signal-to-noise ratio 48 dB

Antenna input: AM loop antenna and external terminal

● **LW SECTION**

Frequency range: 153 – 281 kHz (1 kHz spacing)
Sensitivity: 350 μ V (IEC)
Antenna input: AM loop antenna and external terminal

● **AUDIO SECTION (HTA-D50)**

Power output (Both channels driven) 50 Watts per channel, min. RMS, at 8 ohms from 40 Hz to 20 kHz, with no more than 0.9% total harmonic distortion. [for US, CS]
55 W/ch + 55 W/ch
(1 kHz, 8 ohms, T.H.D. 0.9%)
[for US, CS]
(1 kHz, 8 ohms, T.H.D. 0.7%)
[except US, CS]

Frequency Characteristics 20 Hz – 30 kHz (\pm 3 dB)

Input Sensitivity/ Impedance (for 50 Watts output)

Phono 2.9 mV/47 kohms
Aux/Tape 180 mV/47 kohms

Signal-to-Noise Ratio (IHF-A network input shorted)

Phono 70 dB
CD/AUX/TAPE 80 dB
Graphic Equalizer Control Effect \pm 10 dB (at 63 Hz, 250 Hz, 1 kHz, 4 kHz, 16 kHz)

● **AUDIO SECTION (HTA-D30)**

Power output (Both channels driven) 27 Watts per channel, min. RMS, at 8 ohms from 40 Hz to 20 kHz, with no more than 0.9% total harmonic distortion. [for US, CS]
30 W/ch + 30 W/ch
(1 kHz, 8 ohms, T.H.D. 0.9%)
[for US, CS]
(1 kHz, 8 ohms, T.H.D. 0.7%)
[except US, CS]

Input sensitivity/ impedance (for 30Watts output)

Phono 2.5 mV/50 kohms
Aux/Tape 150 mV/47 kohms

Signal to Noise Ratio (IHF-A network input sorted)

Phono 70 dB
CD/AUX/TAPE 80 dB
Graphic equalizer control \pm 10 dB (at 63 Hz, 250 Hz, 1 kHz, 4 kHz, 16 kHz)

● **GENERAL**

Power requirements AC120V 60 Hz [for US, CS]
 \sim 220V 50 Hz [for KS, ZS, VS, ES]
 \sim 240V 50 Hz [for BS, SA]
 \sim 110V – 120V, \sim 200V – 220V, \sim 230V – 240V, 50/60 Hz (for multi voltage unit only)

Power consumption 140W [for US]
240W 280VA [for CS] } (HTA-D50)
260W [for Europe] }
110W [for CS] } (HTA-D30)
170W [for Europe] }

Dimensions 435(W) x 143(H) x 240(D) mm
Weight 5.6 kg (HTA-D50) 4.6kg (HTA-D30)

Measured Pursuant to the Federal Trade Commission's Trade Regulation Rule on Power Output Claims for Amplifiers.

TECHNISCHE DATEN

● FM-TEIL

Frequenzbereich	87,9 – 107,9 MHz (Kanalabstand 100 kHz) [für US, CS] 87,50–108,00 MHz (Kanalabstand 50 kHz) [außer US, CS]
Netzeempfindlichkeit	13,7 dBf (IHF) 1,5 μ V (IEC)
Signal/Rausch-Abstand	Mono: 69 dB (IHF) Stereo: 67 dB (IHF) [HTA-D50] Mono: 60 dB (DIN Audio Q-peak) 60 dB (DIN Noise Q-peak) Stereo: 58 dB (DIN Audio Q-peak) 58 dB (DIN Noise Q-peak)
Klirrgrad (1 kHz, bei 65 dBf)	Mono: 0,4% Stereo: 0,6%
Frequenzgang Selektivität	30 Hz – 12 kHz \pm 2,5 dB 60 dB (\pm 300 kHz) 65 dB (\pm 400 Hz)
Stereo-Trennung (1 kHz)	40 dB
Antenna input	75 ohms unbalanced

● MW-TEIL

Frequenzbereich	522 – 1611 kHz (Kanalabstand 9 kHz) [außer US, CS] 530 – 1620 kHz (Kanalabstand 10 kHz) [für US, CS]
Empfindlichkeit	40 μ V (IHF Außenantenne) 80 μ V (IEC Außenantenne)
Selektivität	35 dB (\pm 10 kHz)
Störspannungsabstand:	48 dB
Antenneneingang:	MW/LW-Rahmenantenne und Anschluß für externe Antenne

● LW TEIL

Frequenzbereich:	153 – 281 kHz (Kanalabstand 1 kHz)
Empfindlichkeit:	350 μ V (IEC)
Antenneneingang:	MW/LW-Rahmenantenne und Anschluß für externe Antenne

● AUDIO-TEIL (HTA-D50)

Ausgangsleistung Beide Kanäle angesteuert)	50 Watt pro Kanal, min. RMS, bei 8 Ohm von 40 Hz bis 20 kHz, mit nicht mehr als 0,9% Klirrgrad. [für US, CS] 55 W/Kanal + 55 W/Kanal (1 kHz, 8 Ohm, 0,9% Klirrgrad) [für US, CS] (1 kHz, 8 Ohm, 0,7% Klirrgrad) [außer US, CS]
Frequenzgang Eingangsempfindlichkeit/Impedanz (für 50 Watt Ausgang)	20 Hz – 30 Hz (\pm 3 dB)

Phono	2,9 mV/47 kOhm
Aux/Tape	180 mV/47 kOhm
Störspannungsabstand (IHF-A Netzwerk, Eingang kurzgeschlossen)	
Phono	70 dB
CD/AUX/TAPE	80 dB
Graphic Equalizer Klangregelung	\pm 10 dB (bei 63 Hz, 250 Hz, 1 kHz, 4 kHz, 16 kHz)

● AUDIO-TEIL (HTA-30)

Ausgangsleistung (beide Kanäle angesteuert)	27 Watt pro Kanal, min. RMS, bei 8 ohm von 40 Hz bis 20 kHz, mit nicht mehr als 0,9% Klirrgrad. [für US, CS] 30 W/Kanal + 30 W/Kanal (1 kHz, 8 Ohm, 0,9% Klirrgrad) [für US, CS] (1 kHz, 8 Ohm, 0,7% Klirrgrad) [außer US, CS]
--	---

Eingangsempfindlichkeit/Impedanz (für 30 Watt Ausgang)

Phono	2,5 mV/50 kOhm
Aux/Tape	150 mV/47 kOhm
Störspannungsabstand (IHF-A Netzwerk, Eingang kurzgeschlossen)	
Phono	70 dB
CD/AUX/TAPE	80 dB
Graphic Equalizer Klangregelung	\pm 10 dB (bei 63 Hz, 250 Hz, 1 kHz, 4 kHz, 16 kHz)

● GENERALE

Spannungsversorgung	AC120V 60 Hz [für US, CS] \sim 220V 50 Hz [für KS, ZS, VS, ES] \sim 240V 50 Hz [für BS, SA] \sim 110V – 120V, \sim 200V – 220V, \sim 230V – 240V, 50/60 Hz (nur für Mehrfach-Spannung-Gerät)
Stromverbrauch	140W [für US] 240W 280VA [für CS] } (HTA-D50) 260W [für Europa] } 110W [für CS] } (HTA-D30) 170W [für Europa] }
Abmessungen	435(B) \times 143(H) \times 240(T) mm
Gewicht	5,6 kg (HTA-D50) 4,6 kg (HTA-D30)

Änderungen der Konstruktion und technischen Daten bleiben im Sinne der ständigen Verbesserung vorbehalten.

CARACTERISTIQUES TECHNIQUES

● SECTION FM

Band de fréquences	87,9 – 107,9 MHz (intervalle 100 kHz) [pour US, CS] 87,50 – 108,00 MHz (intervalle 50 kHz) [sauf pour US, CS]
Sensibilité utilisable (Mono):	13,7 dBf (IHF) 1,5µV (IEC)
Rapport signal/bruit	Mono: 69 dB (IHF) Stéréo: 67 dB (IHF) Mono: 60 dB (DIN Audio crête-Q) 60 dB (DIN Noise crête-Q) Stéréo: 58 dB (DIN Audio crête-Q) 58 dB (DIN Noise crête-Q)

Distorsion harmonique totale (à 65 dBf, 1 kHz)

Mono:	0,4%
Stéréo:	0,6%

Réponse en fréquence

30 Hz – 12 kHz ± 2,5 dB

Sélectivité

60 dB (± 300 kHz)
65 dB (± 400kHz)

Séparation stéréo (1 kHz)

40 dB

Entrée d'antenne

75 ohms non compensé

● SECTION PO

Gamme de fréquence:	522 – 1.611 kHz (intervalle de 9 kHz) [sauf pour US, CS] 530 – 1620 kHz (intervalle de 10 kHz) [pour US, CS]
----------------------------	---

Sensibilité:

40µV (IHF, antenne extérieure)
80µV (IEC, antenne extérieure)

Séparation:

35 dB (± 10 kHz)

Rapport signal/bruit

48 dB

Entrée d'antenne

Antenne-cadre AM et borne externe

● SECTION GO

Gamme de fréquence:	153 – 281 kHz (intervalle de 1 kHz)
Sensibilité:	350 µV (IEC)
Entrée d'antenne:	Antenne-cadre AM et borne externe

● SECTION AUDIO (HTA-D50)

Puissance de sortie (les deux canaux entraînés)	50 watts par canal, min., RMS, à 8 ohms de 40 Hz à 20 kHz, avec moins de 0,9% de distorsion harmonique totale. [pour US, CS] 55 W/canal + 55 W/canal (1 kHz, 8 Ohms, DHT 0,9%) [pour US, CS] (1 kHz, 8 Ohms, DHT 0,7%) [sauf pour US, CS]
--	---

Caractéristiques de fréquence

10 Hz – 30 kHz (± 3 dB)

Sensibilité d'entrée/impédance (pour 50 watts de sortie)

Phono	2,9 mV/47 kohms
Aux/bande	180 mV/47 kohms

Rapport signal/bruit (Réseau IHF-A entrée court-circuitée)

Phono	70 dB
CD/aux/bande	80 dB

Effet de commande d'égaliseur graphique

± 10 dB (à 63 Hz, 250 Hz, 1 kHz, 4 kHz, 16 kHz)

● SECTION AUDIO (HTA-D30)

Puissance de sortie (les deux canaux entraînés)

27 watts par canal, min., RMS, à 8 ohms de 40 Hz à 20 kHz, avec moins de 0,9% de distorsion harmonique totale. [pour US, CS]
30 W/canal + 30 W/canal (1 kHz, 8 ohms, DHT 0,9%) [pour US, CS]
(1 kHz, 8 ohms, DHT 0,7%) [sauf pour US, CS]

Sensibilité d'entrée/impédance (pour 30 watts de sortie)

Phono	2,5 mV/50 kohms
Aux/bande	150 mV/47 kohms

Rapport signal/bruit (Réseau IHF--A entrée court-circuitée)

Phono	70 dB
CD/aux/bande	80 dB

Commande d'égaliseur graphique

± 10 dB (à 63 Hz, 250 Hz, 1 kHz, 4 kHz, 16 kHz)

● GÉNÉRAL

Alimentation

AC120V 60 Hz [pour US, CS]
~ 220V 50Hz [pour KS, ZS, VS, ES]
~ 240V 50Hz [pour BS, SA]
~ 110V – 120V, ~ 200V – 220V,
~ 230V – 240V 50/60 Hz (pour appareil multi tension)

Consommation

140W [pour US]
240W 280VA [pour CS] } (HTA-D50)
260W [pour Europe]
110W [pour CS] } (HTA-D30)
170W [pour Europe]

Dimensions

435(L) x 143(H) x 210(D) mm

Poids

5,6 kg (HTA-D50) 4,6 kg (HTA-D30)

Les spécifications et la conception sont sujettes à modifications sans préavis pour des raisons d'amélioration.

CIRCUIT BOARD CHECKING AND FRONT PANEL ASS'Y DISASSEMBLY PROCEDURES
PRÜFUNG DER LEITERPLATTE UND VORDERE BEDIENUNGSTAFEL-DEMONTAGE-VORGÄNGE
CONTROLE DE CARTE A CIRCUITS IMPRIMES ET PANEAU AVANT DE DEMONTAGE DE PLAQUE
DECORATIVE

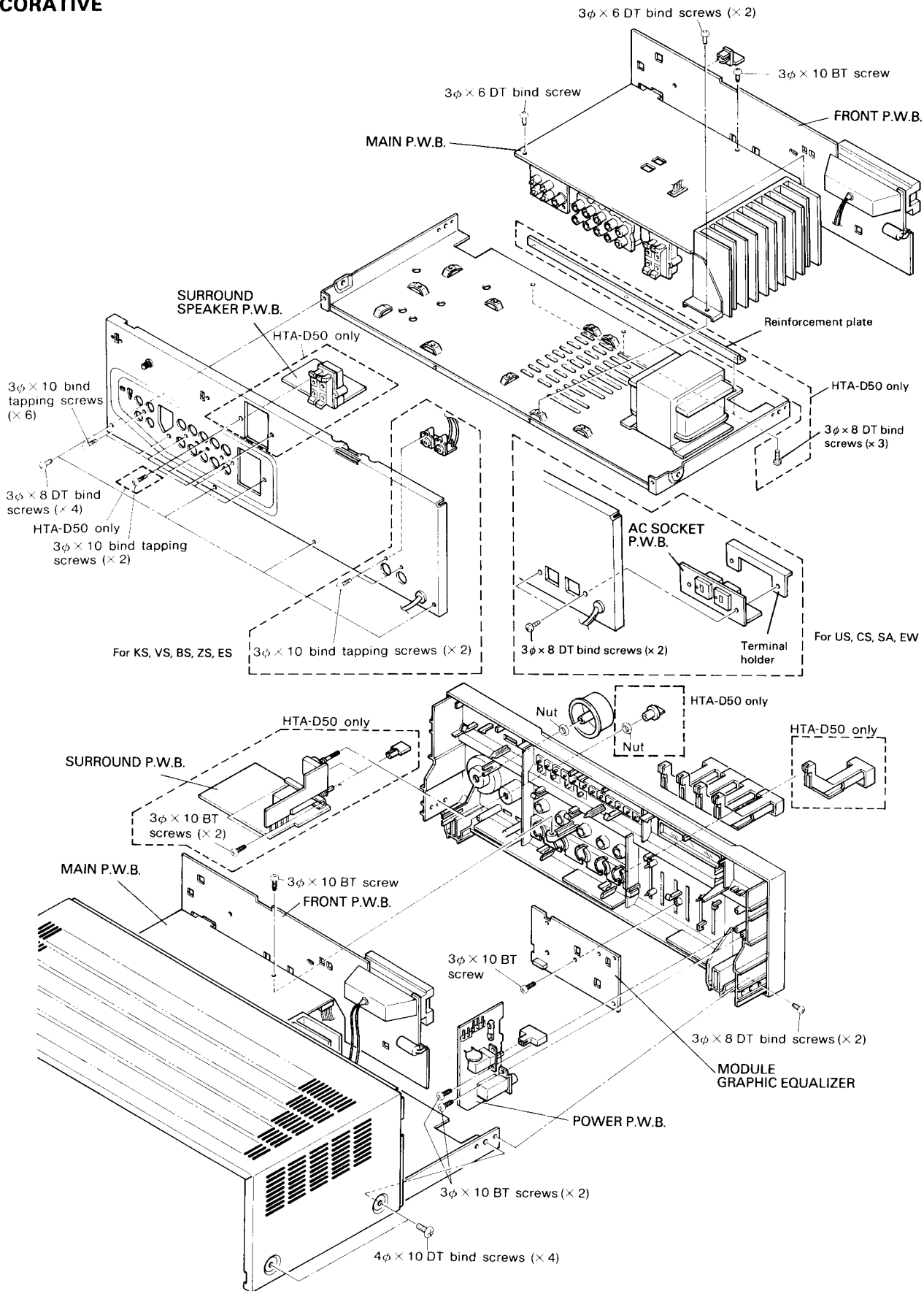

GENERAL ALIGNMENT INSTRUCTIONS

(Note 1)

ALLGEMEINE AUSRICHTANLEITUNG

(Hinweis 1)

INSTRUCTIONS GNERLESS

(Note 1)

● **ADJUSTING POINTS**

● **EINSTELLPUNKT**

● **POINT DE REGLAGE**

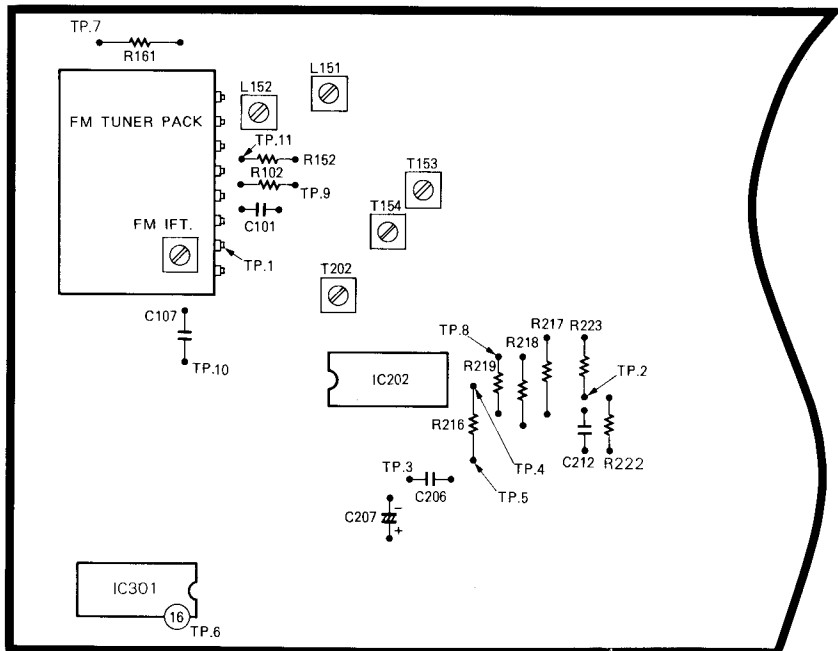

**FM TUNER ALIGNMENT · ABGLEICH DES UKW- TUNERS ·
REGLAGE DE TUNER FM**

FUNCTION: FM VOLUME: MIN FM MODE: MONO
 Funktion: FM (UKW) Lautstärke: Minimum
 FUNCTION: FM VOLUME: MIN

Sweep Generator
 Wobbelgenerator
 Générateur de balayage

Signal Generator
 Signalgenerator
 Générateur de signaux

Oscilloscope
 Oszilloskop
 Oscilloscope

+DC Null Meter
 Gleichstrom-Nullmeter
 -Indicateur d'équilibrage à C.C.

VTVM
 Vakuumröhrenvoltmeter
 Voltmètre électronique

Frequency Counter
 Frequenzzähler
 Fréquencemètre

Dist
 Distortion Meter
 Klirrmesser
 Distorsionmètre

Sequence Folge Ordre	Connection Anschlüsse Connexion		Setting Einstellung Montage		Adjust for Einstellung für Réglage pour	
	Input Eingang Entrée	Output Ausgang Sortie	Tuning Abstimm- anzeige Indicateur d'accord	Signal	Adjust Einstellpunkt Réglage	Indication Indikation Indication
1	 TP.1 0.1μ 100K	Input Eingang Entrée TP.2 100K 0.1μ	-	10.7 MHz	FM IFT (Tuner pack) (Tuner-Teil) (Ensemble Tuner)	(Note 2) (Hinweis 2)
2	 TP.1 0.1μ 100K	Input Eingang Entrée TP.3 100K 0.1μ	-	10.7 MHz	Non-adjustment (No ad- justments are required.) Keine Einstellung (Keine Einstellungen erforderlich.) Pas d'ajustement (aucun ajustement n'est requis.)	(Note 3) (Hinweis 3)

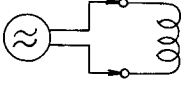
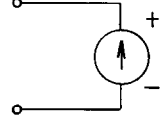
Sequence Folge Ordre	Connection Anschlüsse Connexion		Setting Einstellung Montage		Adjust for Einstellung für Réglage pour	
	Input Eingang Entrée	Output Ausgang Sortie	Tuning Abstimm- anzeige Indicateur d'accord	Signal	Adjust Einstellpunkt Réglage	Indication Indikation Indication
3 Covering Bereich Portée	-	-				(Note 4) (Hinweis 4)
4 Tracking Nachführung Alignement	-	-				(Note 4) (Hinweis 4)
5 Discriminator Diskriminator Discriminateur	ANT. Terminal Antennen-Anschluß Borne d'antenne  1 kHz, 60 dBµ 40 kHz (dev.)	TP.4  TP.5	89.9 MHz	89.9 MHz	—	Check that the meter reading indicates 0 ± 200 mV. Überprüfen, daß das Meßinstrument 0 ± 200 mV anzeigt. Vérifier que le compteur indique 0 ± 200 mV.

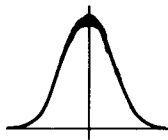

Fig. 1 Abb. 1

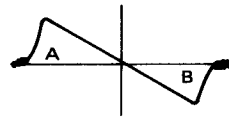

Fig. 2 Abb. 2

- Note 1:** Perform adjustment at least 3 minutes after the power has been switched ON.
- Note 2:** Apply low-input signals from a sweep generator (with a small amount of noise superimposed on IF waveform as in Fig. 1), and adjust the waveform until it becomes maximum and symmetrical.
- Note 3:** Confirm that the A and B are symmetry and linear as shown in Fig. 2. Since the ceramic discriminator is used, no adjustments are required for S-curve.
- Note 4:** FM Tuner pack is aligned before shipping, so it is not necessary to adjust covering and tracking.
- Hinweis 1:** Den Abgleich frühestens 3 Minuten nach dem Einschalten des Netzalters durchführen.
- Hinweis 2:** Mit Hilfe eines Wobbelgenerators sind niederpegelige Signale (wie in Abb. 1 gezeigt mit geringer Rauschstörung auf der Zwischenfrequenz-Wellenform) anzulegen, und dann ist so abzugleichen, daß die Wellenform maximal und symmetrisch wird.
- Hinweis 3:** Überprüfen, daß A und B symmetrisch und linear sind, siehe Abb. 2. Da ein Keramik-Diskriminator verwendet wird, sind für die S-Kurve keine Einstellungen erforderlich.
- Hinweis 4:** Das UKW-Empfangsteil wurde vor dem Versand eingestellt, so daß der Bereich und die Nachführung nicht einjustiert werden müssen.
- Note 1:** Effectuer ce réglage au moins 3 minutes après la mise sous tension.
- Note 2:** Utiliser un générateur de balayage et appliquer des signaux d'entrée à faible niveau (avec un faible chevauchement de bruit dans la forme d'onde à F.I. comme représenté sur la Fig. 1), et régler la forme d'onde jusqu'à ce qu'elle devienne maximale et symétrique.
- Note 3:** S'assurer que A et B sont symétriques et linéaires comme indiqué dans la figure 2. Du fait d'un discriminateur à céramique est utilisé, aucun ajustement n'est requis pour la courbe S.
- Note 4:** L'étage tuner FM est réglé avant son envoi, il est donc inutile d'effectuer le réglage de portée et d'alignement.

AM TUNER ALIGNMENT · ABGLEICH DES AM-TUNERS. REGLAGE DE TUNER AM

FUNCTION: AM

Funktion: AM (UKW)

FUNCTION: AM

MODULATION: 400 Hz 30%

Modulation: 400 Hz 30%

MODULATION: 400 Hz 30%

Sequence Folge Ordre	Connection Anschlüsse Connexion		Setting Einstellung Montage		Adjust for Einstellung für Réglage pour	
	Input Eingang Entrée	Output Ausgang Sortie	Tuning Abstimm- anzeige Indicateur d'accord	Signal	Adjust Einstellpunkt Réglage	Indication Indikation Indication
1 IF Amp. ZF-Verstärker Amplificateur de fréquence intermédiaire	Output Ausgang Sortie TP.7 100K 0.1μ	Input Eingang Entrée TP.8 100K 0.1μ	-	450 kHz	T202	 (Note 5) (Hinweis 5)
2 Tracking Vorstufe Alignement	Loop antenna Rahmenantenne Antenne en carbon 	REC out Aufnahme-Ausgang Sortie enregistrement 	600 kHz or 603 kHz	600 kHz or 603 kHz	L151	Output max. (Note 6) (Hinweis 6)
			164 kHz	164 kHz	L152	

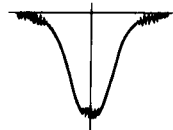

Fig. 3
Abb. 3

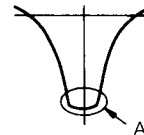

Fig. 4
Abb. 4

Note 5: When the output signal of the sweep generator is low, make adjustment until the waveform becomes maximum and symmetrical, as shown in Fig. 3. Then, increase the output level sweep generator, and adjust the waveform until the band of portion A becomes as flat as possible, as shown in Fig. 4.

Note 6: At first, set the input level to 74 dB/m. As the adjustment advances, reduce the input level to an allowable minimum level (approx. 60 dB), and repeat the adjustment until the maximum output is obtained at the specified frequency. Since the trimmer capacitor is not provided, the tracking adjustment at the upper limit frequency is not required.

Hinweis 5: Wenn das Ausgangssignal des Wobbelgenerators niedrig ist, abgleichen, bis die Wellenform wie in Abb. 3 gezeigt maximal und symmetrisch ist. Dann den Ausgangspegel des Wobbelgenerators erhöhen, so daß der in Abb. 4 gezeigte Bandbereich von Teil A so flach wie möglich wird.

Hinweis 6: Zuerst den Eingangspegel auf 74 dB/m einsteuern. Mit fortschreitender Einstellung den Eingangspegel auf den zulässigen Mindestpegel (etwa 60 dB) verringern und die Einstellung wiederholen, bis der maximale Ausgang bei der festgelegten Frequenz erhalten wird. Da kein Trimmer-Kondensator vorhanden ist, ist die Spurhalte-Einstellung an der oberen Grenzfrequenz nicht erforderlich.

Note 5: Dans le cas où le signal de sortie du générateur de balayage est faible, procéder à un réglage jusqu'à ce que la forme d'onde devienne maximale et symétrique comme montré sur la Fig. 3. Augmenter ensuite le niveau de sortie du générateur de balayage, et régler la forme d'onde de façon que la bande de la partie A devienne la plus plate possible, comme indiqué sur la Fig. 4.

Note 6: En premier lieu, régler le niveau d'entrée à 74 dB/m. A mesure que le réglage avance, réduire le niveau d'entrée à un niveau minimal admissible (environ 60 dB), et répéter le réglage jusqu'à ce que la sortie maximale soit obtenue à la fréquence spécifiée. Du fait que la résistance de déclenchement n'est pas fournie, le réglage de l'alignement à la fréquence de limite supérieure n'est pas requis.

DIAGRAM
PLAN
CIRCUIT

- ※ : Axial lead cylindrical ceramic capacitor
- ※ : Zylindrischer Keramikcondensator mit axialer Zuleitung
- ※ : Condensateur céramique cylindrique à conducteur axial

CAUTION
Use the electrolytic capacitors
diameter of them is more than

50

TUNER SECTION

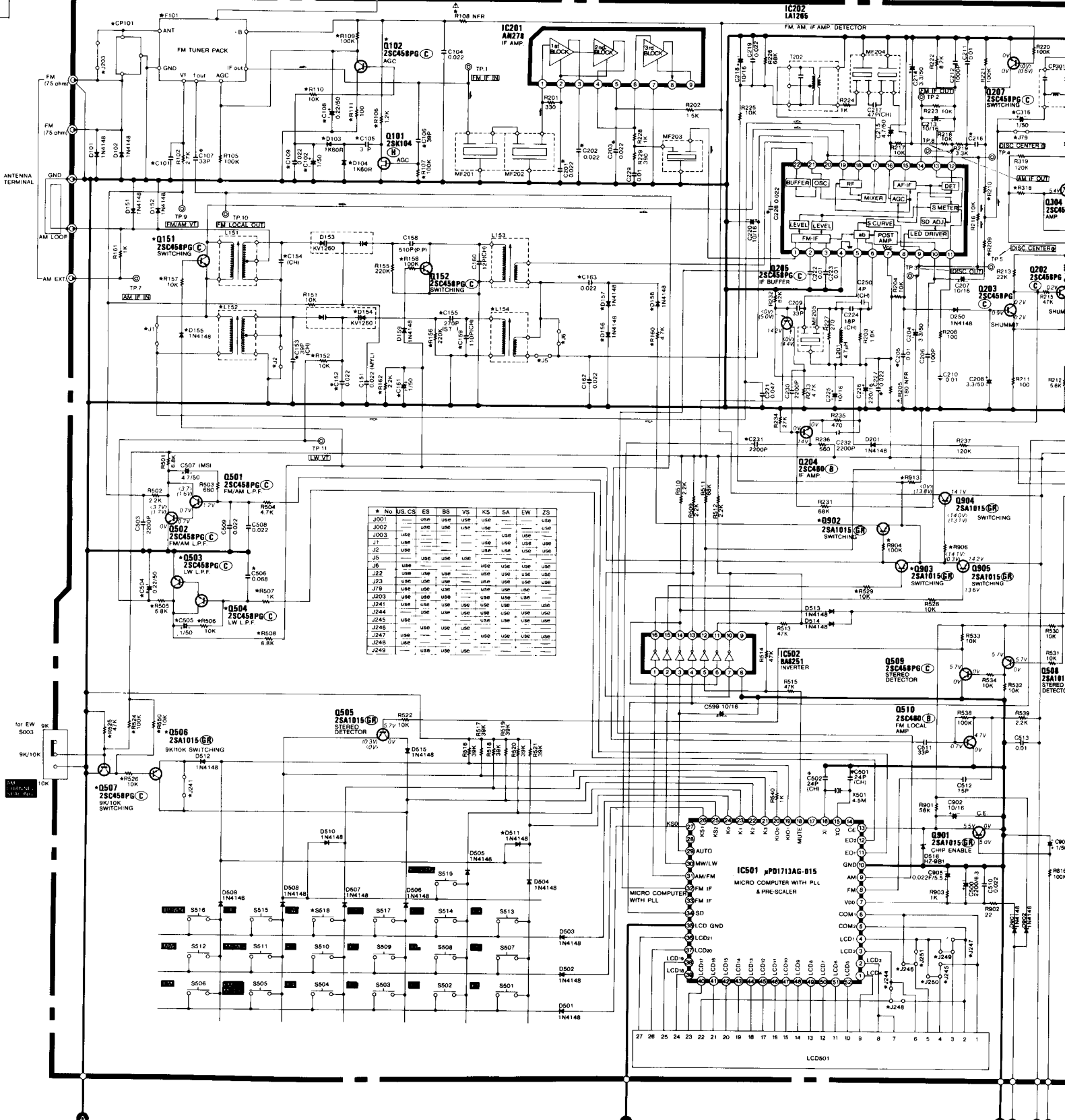

No.	US.	ES	BS	VS	XS	SA	EW	ZS
J001	use	use	use	use	use	use	use	use
J002	use	use	use	use	use	use	use	use
J003	use	use	use	use	use	use	use	use
J1	use	use	use	use	use	use	use	use
J2	use	use	use	use	use	use	use	use
J5	use	use	use	use	use	use	use	use
J6	use	use	use	use	use	use	use	use
J22	use	use	use	use	use	use	use	use
J23	use	use	use	use	use	use	use	use
J79	use	use	use	use	use	use	use	use
J203	use	use	use	use	use	use	use	use
J241	use	use	use	use	use	use	use	use
J244	use	use	use	use	use	use	use	use
J245	use	use	use	use	use	use	use	use
J248	use	use	use	use	use	use	use	use
J247	use	use	use	use	use	use	use	use
J248	use	use	use	use	use	use	use	use
J249	use	use	use	use	use	use	use	use

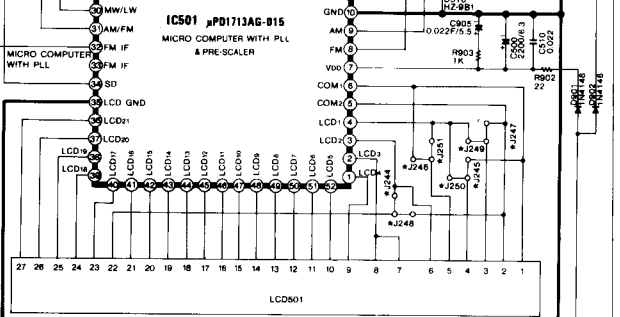

ceramic capacitor
 kondensator mit axialer Zuleitung
 capaciteur cylindrique à conducteur axial

CAUTION
 Use the electrolytic capacitors with explosion-proof valve when the diameter of them is more than 10 mmφ.

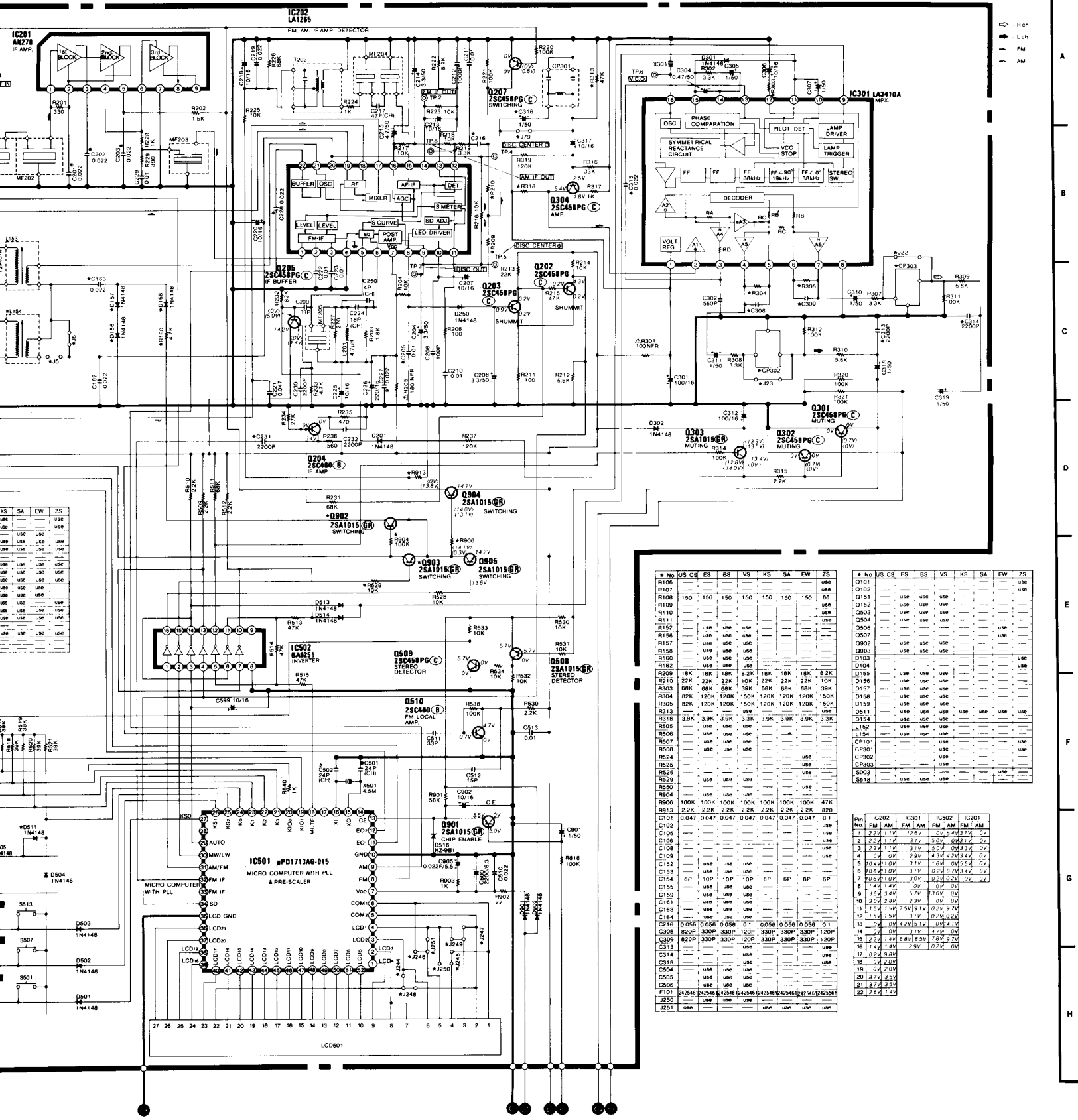

No.	US	CS	ES	BS	VS	KS	SA	EW	ZS
R106	use	use	use	use	use	use	use	use	use
R107	use	use	use	use	use	use	use	use	use
R108	150	150	150	150	150	150	150	68	use
R109	use	use	use	use	use	use	use	use	use
R110	use	use	use	use	use	use	use	use	use
R111	use	use	use	use	use	use	use	use	use
R152	use	use	use	use	use	use	use	use	use
R156	use	use	use	use	use	use	use	use	use
R157	use	use	use	use	use	use	use	use	use
R158	use	use	use	use	use	use	use	use	use
R180	use	use	use	use	use	use	use	use	use
R182	use	use	use	use	use	use	use	use	use
R208	18K	18K	18K	8.2K	18K	18K	18K	8.2K	use
R210	22K	22K	22K	10K	22K	22K	22K	10K	use
R303	88K	88K	88K	39K	88K	88K	88K	39K	use
R304	82K	120K	120K	50K	120K	120K	120K	150K	use
R305	82K	120K	120K	150K	120K	120K	120K	150K	use
R313	use	use	use	use	use	use	use	use	use
R316	3.9K	3.9K	3.9K	3.3K	3.9K	3.9K	3.9K	3.3K	use
R505	use	use	use	use	use	use	use	use	use
R506	use	use	use	use	use	use	use	use	use
R507	use	use	use	use	use	use	use	use	use
R508	use	use	use	use	use	use	use	use	use
R524	use	use	use	use	use	use	use	use	use
R525	use	use	use	use	use	use	use	use	use
R526	use	use	use	use	use	use	use	use	use
R529	use	use	use	use	use	use	use	use	use
R550	use	use	use	use	use	use	use	use	use
R904	use	use	use	use	use	use	use	use	use
R906	100K	100K	100K	100K	100K	100K	100K	47K	use
R913	2.2K	2.2K	2.2K	2.2K	2.2K	2.2K	2.2K	820	use
C101	0.047	0.047	0.047	0.047	0.047	0.047	0.047	0.1	use
C102	use	use	use	use	use	use	use	use	use
C105	use	use	use	use	use	use	use	use	use
C106	use	use	use	use	use	use	use	use	use
C108	use	use	use	use	use	use	use	use	use
C109	use	use	use	use	use	use	use	use	use
C152	use	use	use	use	use	use	use	use	use
C153	use	use	use	use	use	use	use	use	use
C154	6P	10P	10P	10P	6P	6P	6P	6P	use
C155	use	use	use	use	use	use	use	use	use
C159	use	use	use	use	use	use	use	use	use
C161	use	use	use	use	use	use	use	use	use
C163	use	use	use	use	use	use	use	use	use
C164	use	use	use	use	use	use	use	use	use
C216	0.056	0.056	0.056	0.1	0.056	0.056	0.056	0.1	use
C308	820P	330P	330P	120P	330P	330P	330P	120P	use
C309	820P	330P	330P	120P	330P	330P	330P	120P	use
C313	use	use	use	use	use	use	use	use	use
C314	use	use	use	use	use	use	use	use	use
C316	use	use	use	use	use	use	use	use	use
C318	use	use	use	use	use	use	use	use	use
C319	use	use	use	use	use	use	use	use	use
C324	use	use	use	use	use	use	use	use	use
C325	use	use	use	use	use	use	use	use	use
C505	use	use	use	use	use	use	use	use	use
C506	use	use	use	use	use	use	use	use	use
F101	24246	82546	82546	82546	82546	82546	82546	82546	82546
J250	use	use	use	use	use	use	use	use	use
J251	use	use	use	use	use	use	use	use	use

**WIRING DIAGRAM
TOP PLAN
OF CIRCUIT**

- ※: Axial lead cylindrical ceramic capacitor
- ※: Zylindrischer Keramikcondensator mit axialer Zuleitung
- ※: Condensateur céramique cylindrique à conducteur axial

CAUTION
Use the electrolytic capacitor
diameter of them is more than

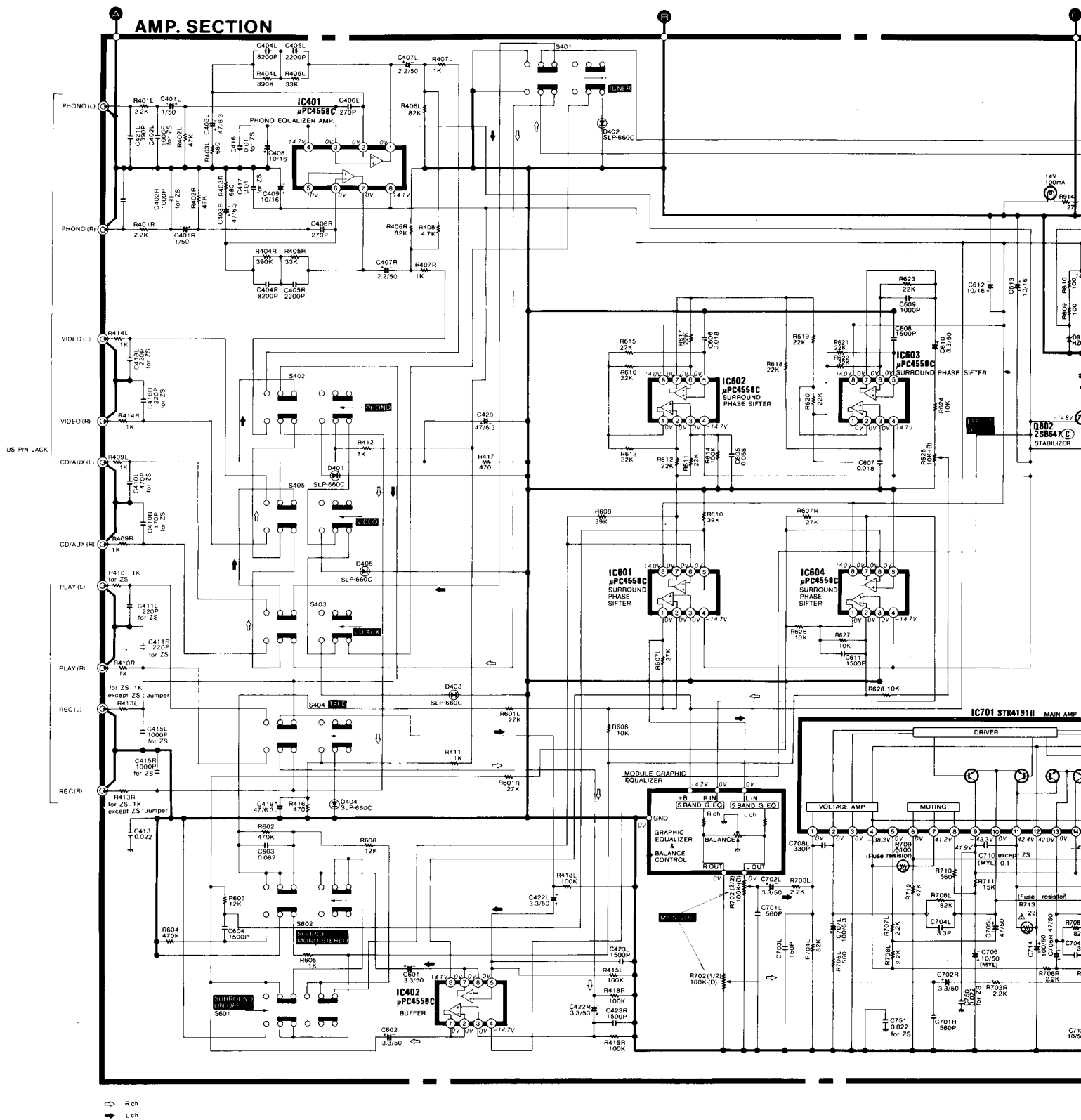

ical ceramic capacitor
amikkondensator mit axialer Zuleitung
ramique cylindrique à conducteur axial

CAUTION
Use the electrolytic capacitors with explosion-proof valve when the diameter of them is more than 10 mmφ.

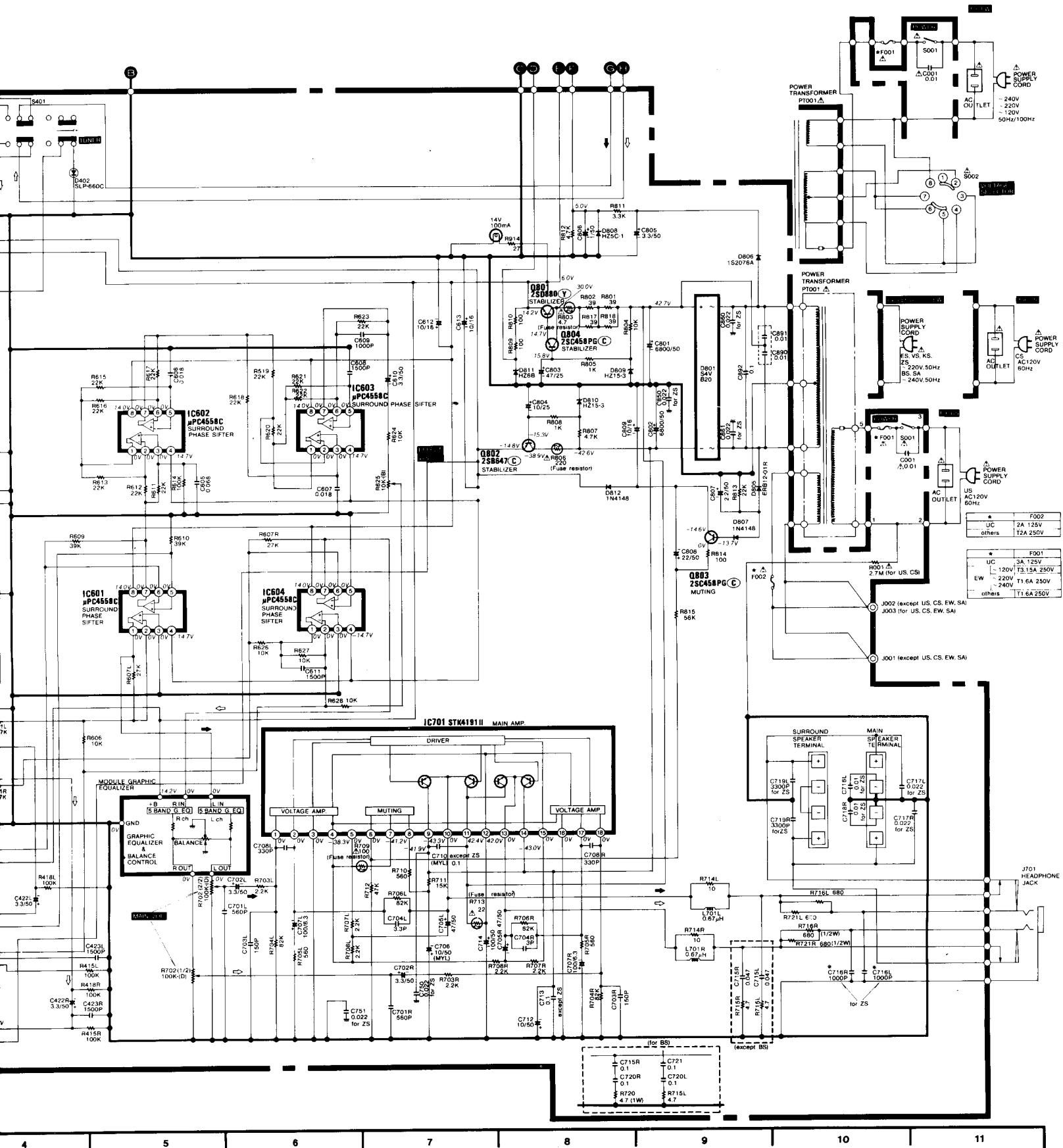

△	F002
△	UC 2A 125V
△	others T2A 250V
△	F001
△	UC 3A 125V
△	UC 120V T3.15A 250V
△	EW 220V T1.6A 250V
△	others T1.6A 250V

CIRCUIT DIAGRAM
SCHALTPLAN
PLAN DE CIRCUIT

- ※ : Axial lead cylindrical ceramic capacitor
- ※ : Zylindrischer Keramikkondensator mit axialer Zuleitung
- ※ : Condensateur céramique cylindrique à conducteur axial

CAUTION
Use the elect
diameter of th

HTA-D30

TUNER SECTION (FM POSITION < > AM POSITION)

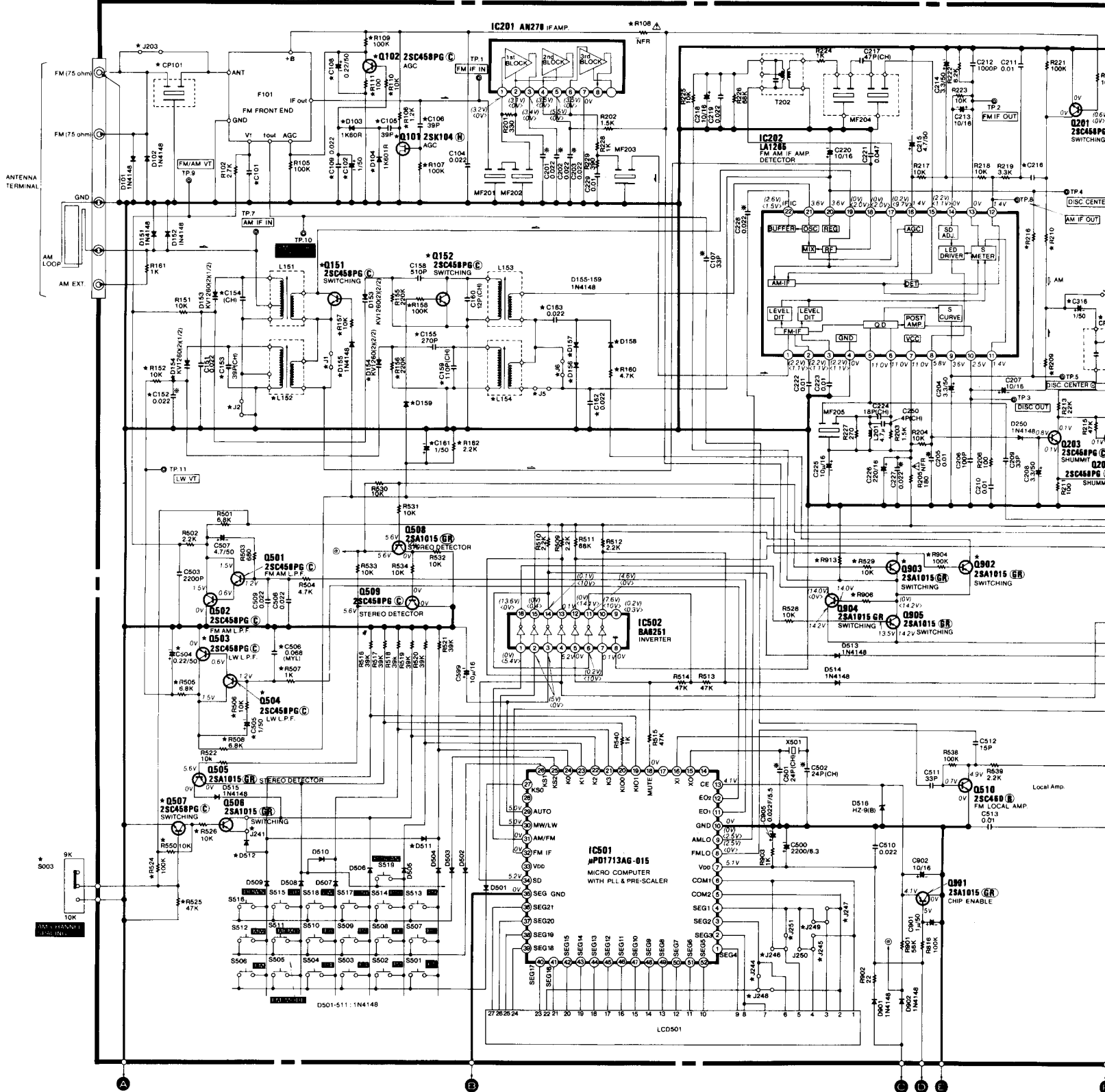

CIRCUIT DIAGRAM
SCHALTPLAN
PLAN DE CIRCUIT

- ※ : Axial lead cylindrical ceramic capacitor
- ※ : Zylindrischer Keramikcondensator mit axialer Zuleitung
- ※ : Condensateur céramique cylindrique à conducteur axial

CAUTION
 Use the elect
 diameter of t

AMP. SECTION

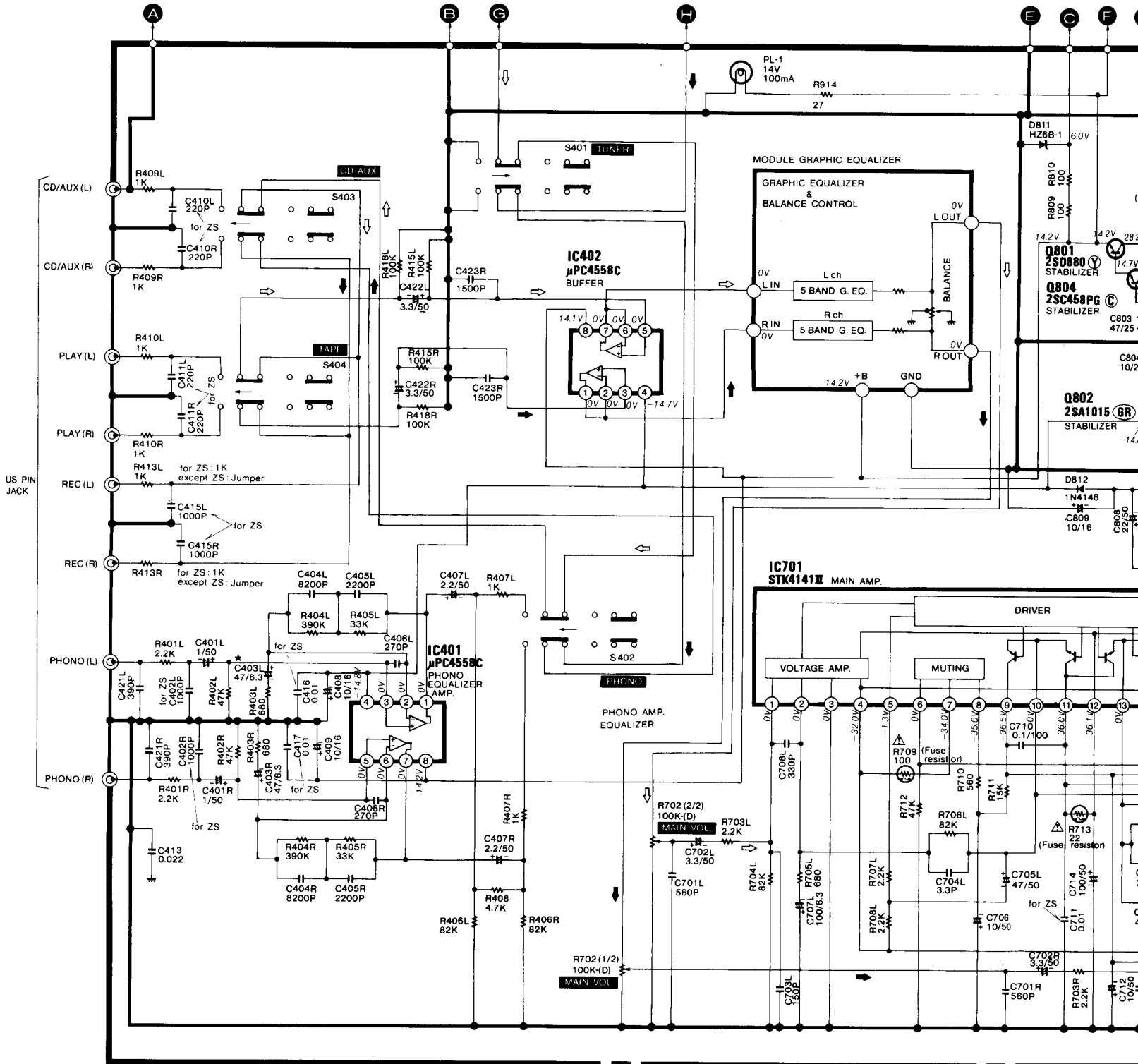

⇨ : R ch
 ⇩ : L ch

1 | 2 | 3 | 4 | 5

for Zuleitung
 ucteur axial

CAUTION
 Use the electrolytic capacitors with explosion-proof valve when the diameter of them is more than 10 mmφ.

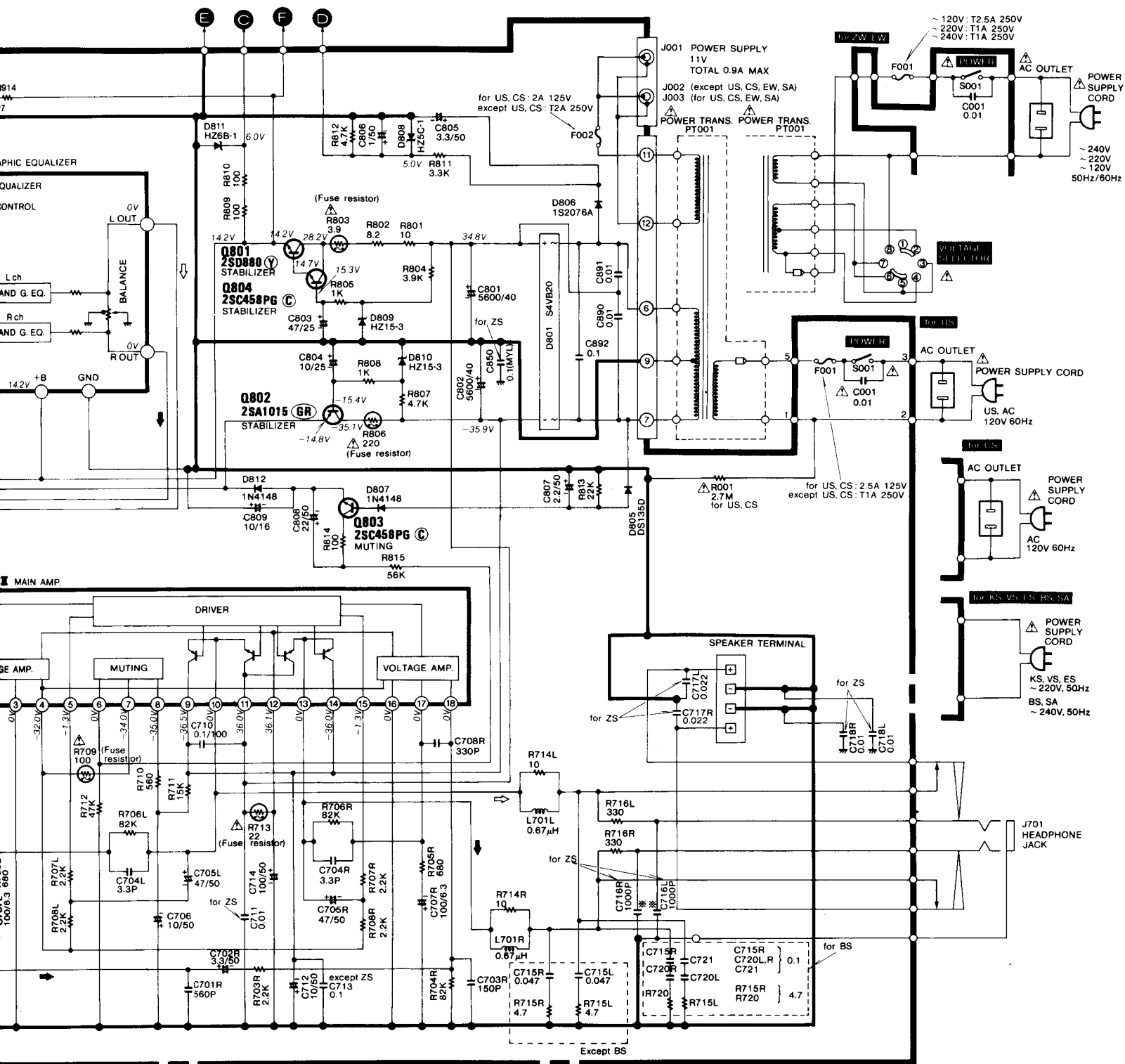

PRINTED WIRING BOARD
PRINTPLATTEN
PLAN DE BASE

[■■■■ : Earth, ■■■■■ : Other]

- ※ : Axial lead cylindrical ceramic capacitor
- ※ : Zylindrischer Keramik Kondensator mit axialer Zuleitung
- ※ : Condensateur céramique cylindrique à conducteur axial

HTA-D50

FRONT P.W.B.

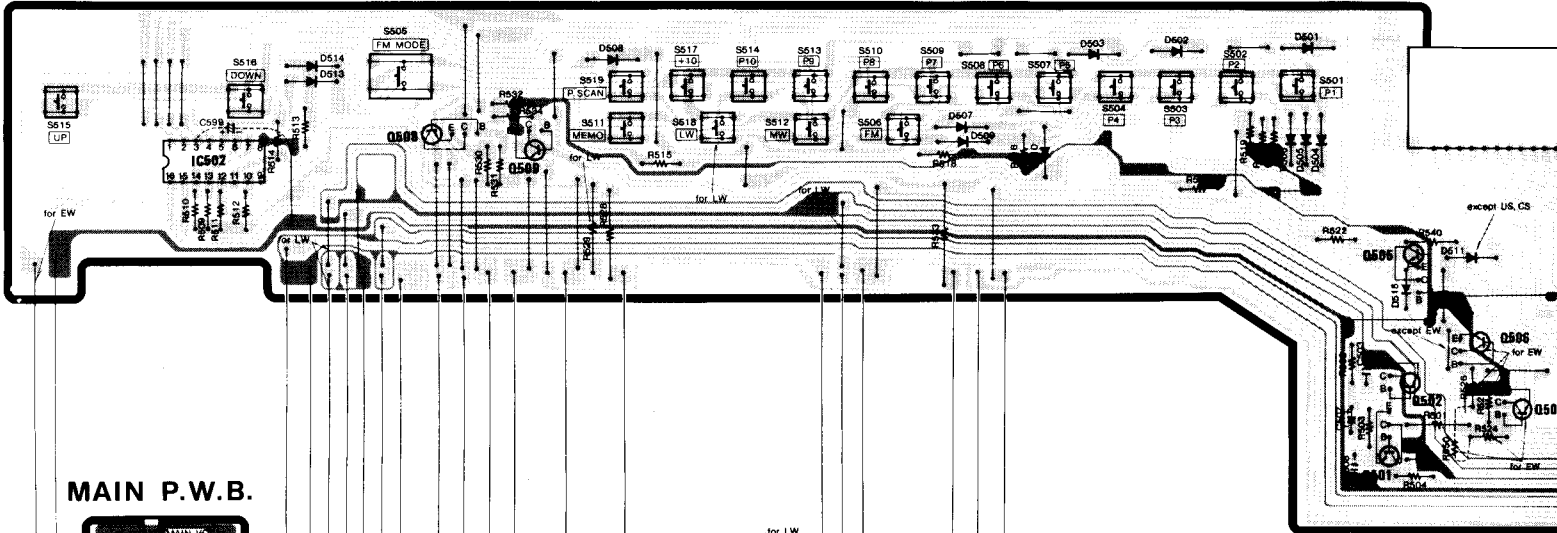

MAIN P.W.B.

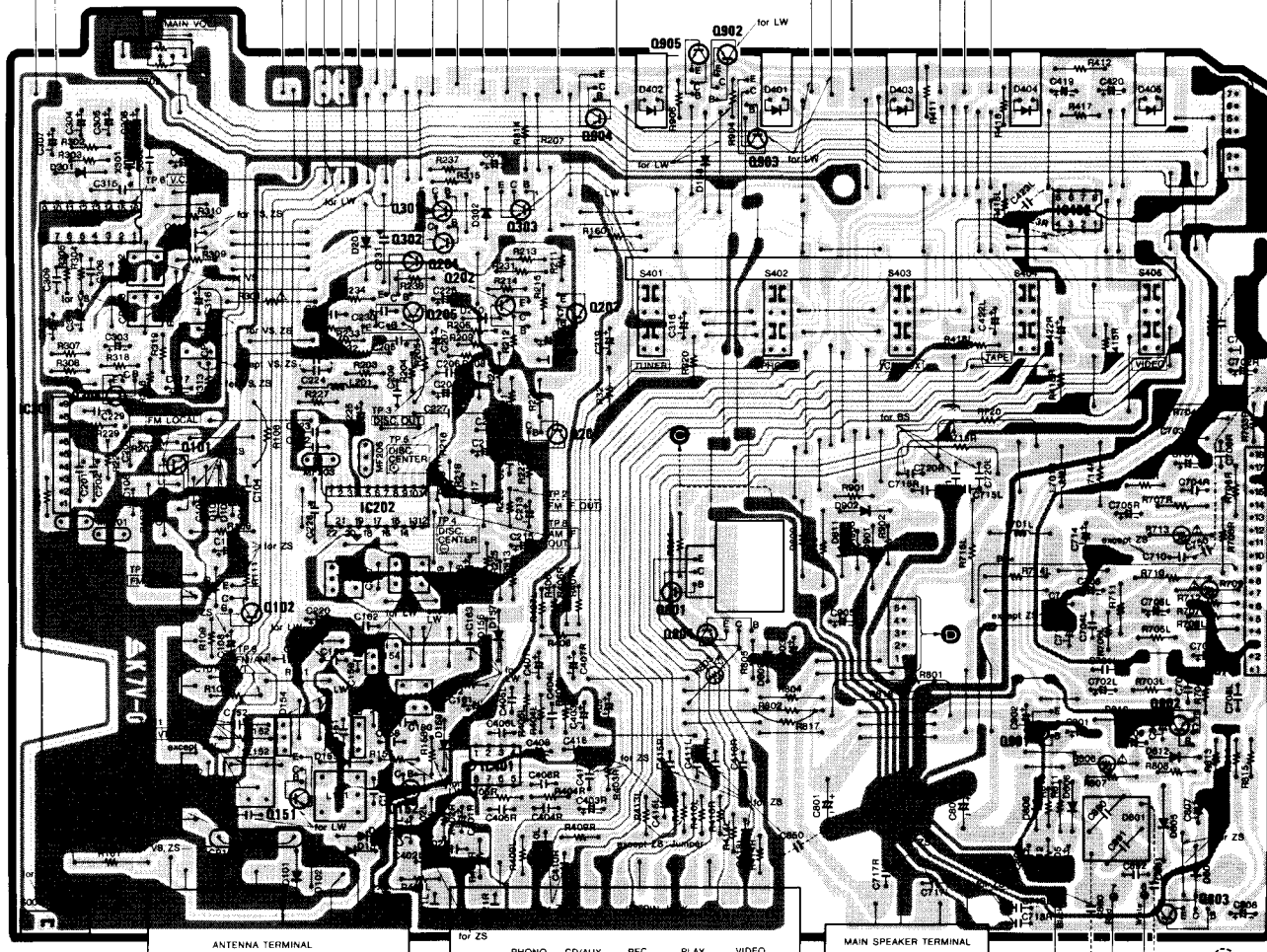

SURROUND
TO MODULE GRAPHIC EQUALIZER

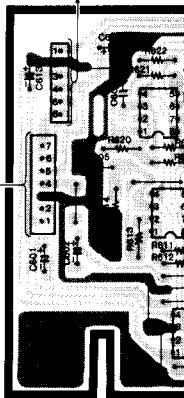

POWER P.W.B.

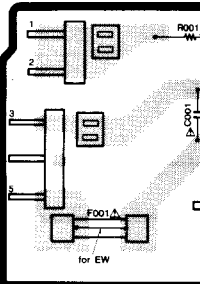

ANTENNA TERMINAL for ZS PHONO CD/AUX REC PLAY VIDEO MAIN SPEAKER TERMINAL

AM FM FM (75 ohm) INPUT TAPE INPUT R L for EW LW ES, VS, BS

1 2 3 4 5 6

**PRINTED WIRING BOARD
PRINTPLATTEN
PLAN DE BASE**

HTA-D30

[■ : Earth, [□ : Other]

- ※ : Axial lead cylindrical ceramic capacitor
- ※ : Zylindrischer Keramikcondensator mit axialer Zuleitung
- ※ : Condensateur céramique cylindrique à conducteur axial

FRONT P.W.B.

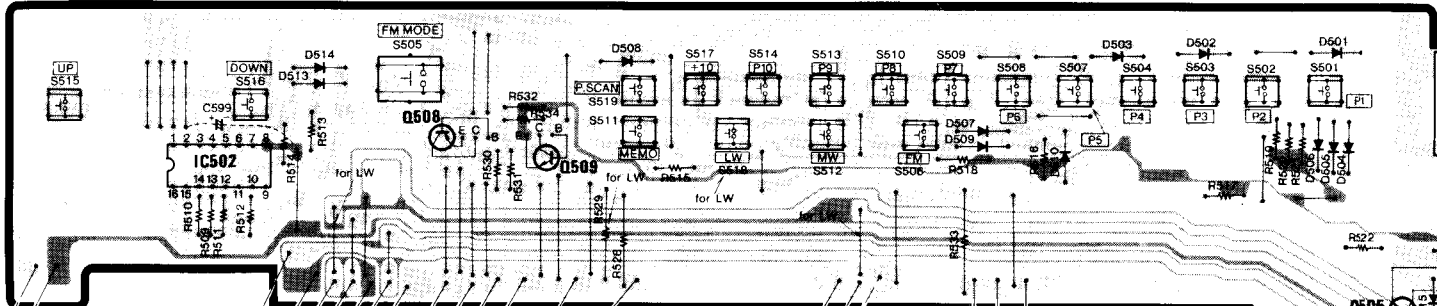

MAIN P.W.B.

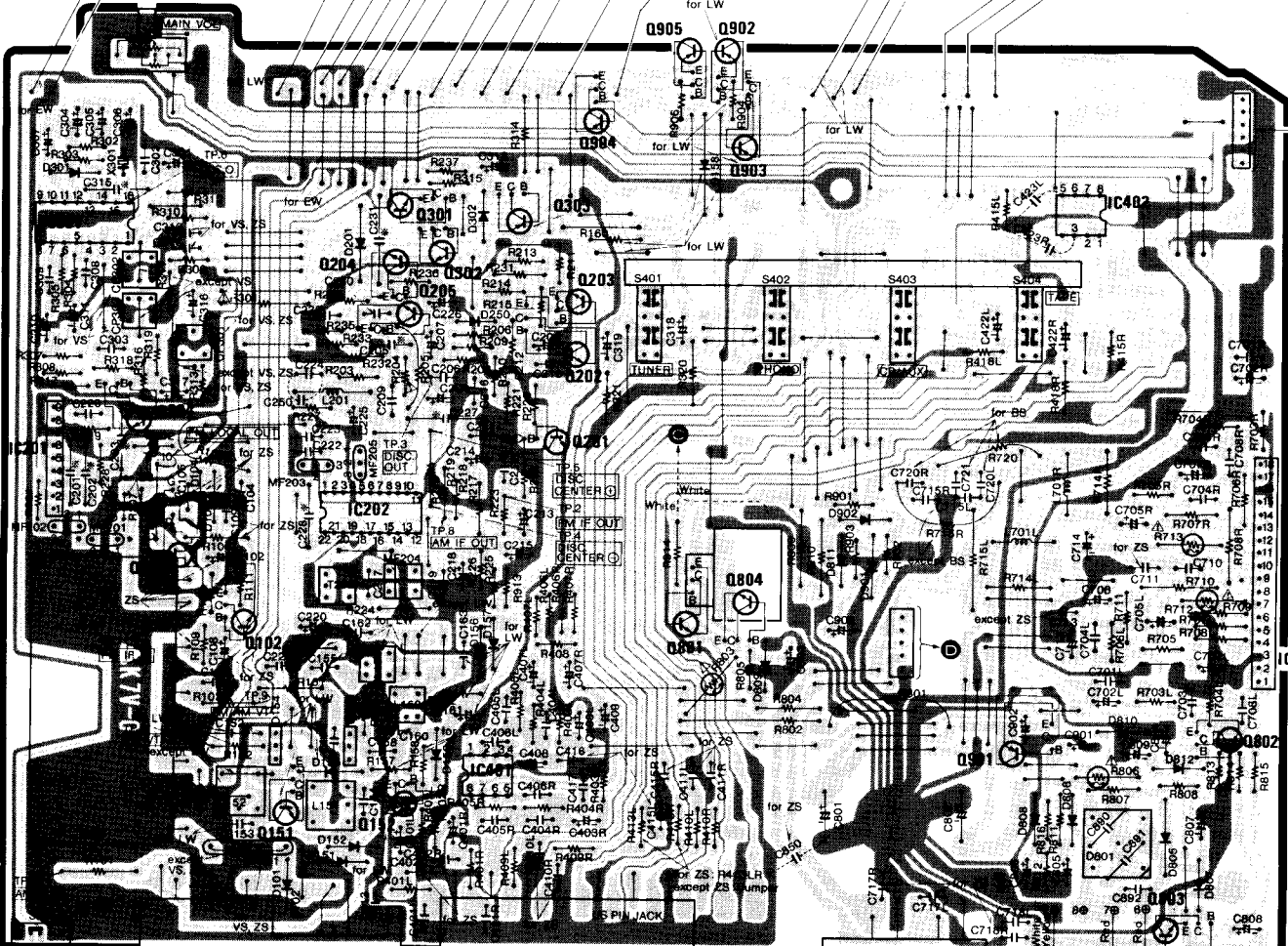

To MODULE GRAPHIC EQUALIZER

AC SOCKET P.W.B.

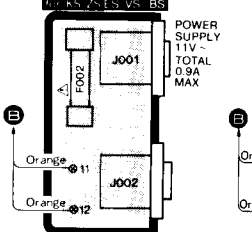

POWER P.W.B.

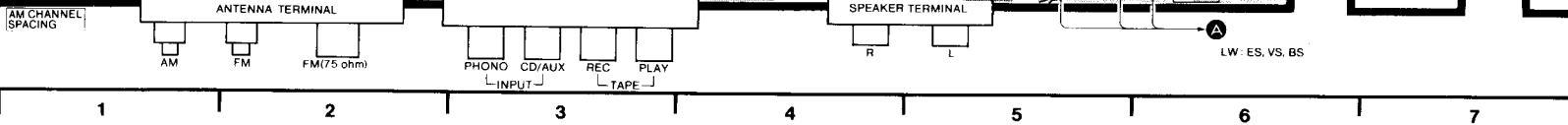
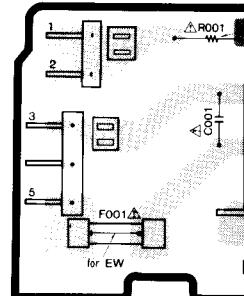

axial ceramic capacitor
 keramikkondensator mit axialer Zuleitung
 condensateur céramique cylindrique à conducteur axial

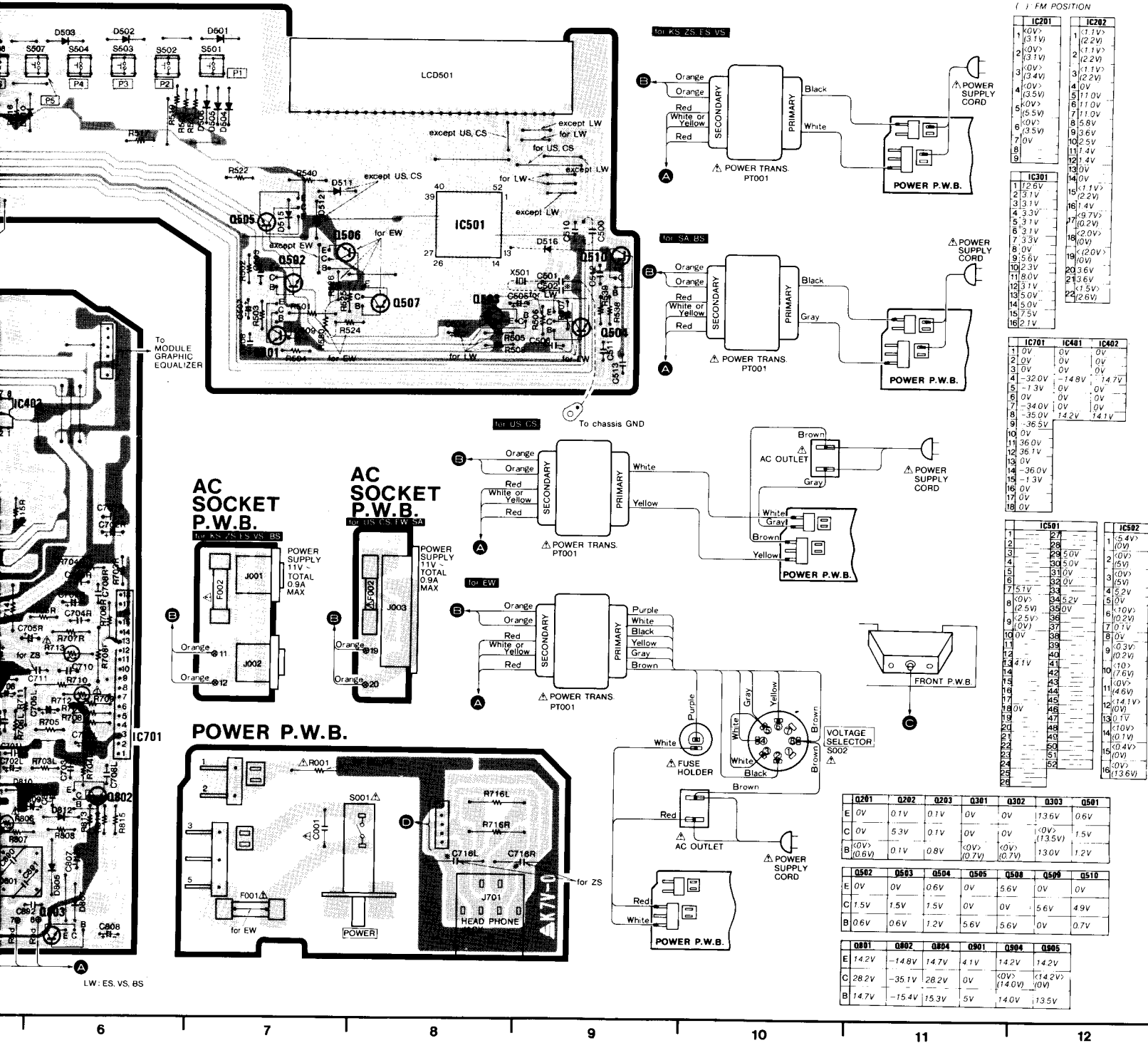

< > AM SECTION
 () FM POSITION

IC201	IC202
1 <0V>	1 <1.1V>
2 <3.1V>	2 <1.1V>
3 <0V>	3 <1.1V>
4 <3.1V>	4 <0V>
5 <0V>	5 <1.1V>
6 <3.1V>	6 <1.1V>
7 <0V>	7 <1.1V>
8 <3.1V>	8 <1.1V>
9 <0V>	9 <1.1V>
10 <3.1V>	10 <1.1V>
11 <0V>	11 <1.1V>
12 <3.1V>	12 <1.1V>
13 <0V>	13 <1.1V>
14 <3.1V>	14 <1.1V>
15 <0V>	15 <1.1V>
16 <3.1V>	16 <1.1V>
17 <0V>	17 <1.1V>
18 <3.1V>	18 <1.1V>
19 <0V>	19 <1.1V>
20 <3.1V>	20 <1.1V>
21 <0V>	21 <1.1V>
22 <3.1V>	22 <1.1V>
23 <0V>	23 <1.1V>
24 <3.1V>	24 <1.1V>
25 <0V>	25 <1.1V>
26 <3.1V>	26 <1.1V>

IC301	IC302
1 <1.26V>	1 <1.1V>
2 <3.1V>	2 <1.1V>
3 <3.1V>	3 <1.1V>
4 <3.1V>	4 <1.1V>
5 <3.1V>	5 <1.1V>
6 <3.1V>	6 <1.1V>
7 <3.1V>	7 <1.1V>
8 <0V>	8 <1.1V>
9 <3.1V>	9 <1.1V>
10 <3.1V>	10 <1.1V>
11 <3.1V>	11 <1.1V>
12 <3.1V>	12 <1.1V>
13 <3.1V>	13 <1.1V>
14 <3.1V>	14 <1.1V>
15 <3.1V>	15 <1.1V>
16 <3.1V>	16 <1.1V>
17 <3.1V>	17 <1.1V>
18 <3.1V>	18 <1.1V>
19 <3.1V>	19 <1.1V>
20 <3.1V>	20 <1.1V>
21 <3.1V>	21 <1.1V>
22 <3.1V>	22 <1.1V>
23 <3.1V>	23 <1.1V>
24 <3.1V>	24 <1.1V>
25 <3.1V>	25 <1.1V>
26 <3.1V>	26 <1.1V>

IC701	IC401	IC402
1 <1.0V>	0V	0V
2 <0V>	0V	0V
3 <0V>	0V	0V
4 <-3.0V>	<-1.48V>	<-1.47V>
5 <-1.3V>	0V	0V
6 <0V>	0V	0V
7 <-3.4V>	0V	0V
8 <-3.5V>	1.42V	1.41V
9 <-3.6V>		
10 <0V>		
11 <3.6V>		
12 <3.6V>		
13 <3V>		
14 <-3.0V>		
15 <-1.3V>		
16 <0V>		
17 <0V>		
18 <0V>		

IC501	IC502
1 <27>	1 <5.4V>
2 <27>	2 <0V>
3 <27>	3 <0V>
4 <27>	4 <0V>
5 <27>	5 <0V>
6 <27>	6 <0V>
7 <27>	7 <0V>
8 <27>	8 <0V>
9 <27>	9 <0V>
10 <27>	10 <0V>
11 <27>	11 <0V>
12 <27>	12 <0V>
13 <27>	13 <0V>
14 <27>	14 <0V>
15 <27>	15 <0V>
16 <27>	16 <0V>
17 <27>	17 <0V>
18 <27>	18 <0V>
19 <27>	19 <0V>
20 <27>	20 <0V>
21 <27>	21 <0V>
22 <27>	22 <0V>
23 <27>	23 <0V>
24 <27>	24 <0V>
25 <27>	25 <0V>
26 <27>	26 <0V>

Q201	Q202	Q203	Q301	Q302	Q303	Q501
E 0V	0.1V	0.1V	0V	0V	<1.36V>	0.6V
C 0V	5.3V	0.1V	0V	0V	<0V>	1.5V
B <0.6V>	0.1V	0.8V	<0V>	<0.7V>	<1.35V>	1.2V

Q502	Q503	Q504	Q505	Q508	Q509	Q510
E 0V	0V	0.6V	0V	5.6V	0V	0V
C 1.5V	1.5V	1.5V	0V	0V	5.6V	4.9V
B 0.6V	0.6V	1.2V	5.6V	5.6V	0V	0.7V

Q801	Q802	Q804	Q901	Q904	Q905
E 14.2V	<-14.8V>	14.7V	4.1V	14.2V	14.2V
C 28.2V	<-35.1V>	28.2V	0V	<0V>	<14.2V>
B 14.7V	<-15.4V>	15.3V	5V	14.0V	<13.5V>

FRONT AND REAR PANEL · VORDERE UND HINTER BEDIENTUNGSTAFEL · PANNEAUX AVANT ET ARRIERE

HTA-D50

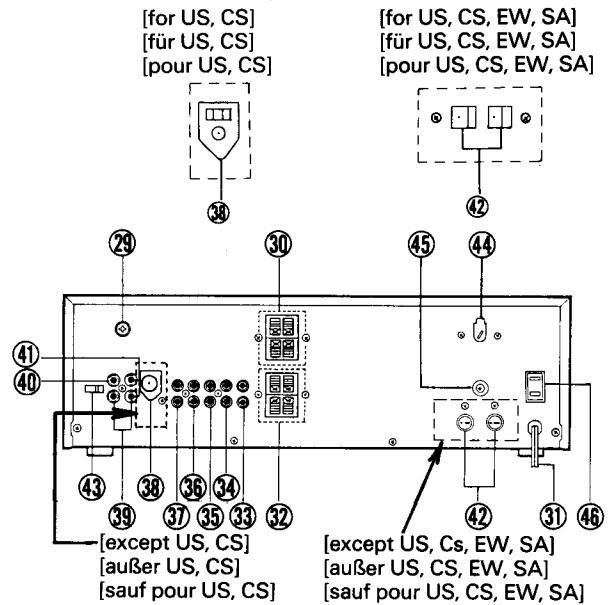
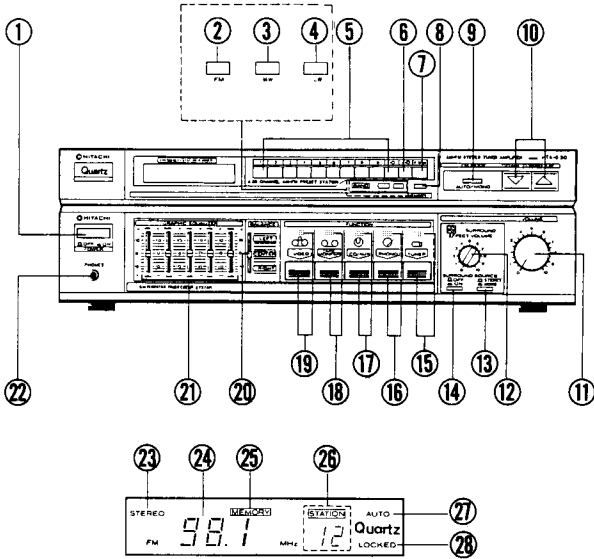

- ① Power switch (POWER)
- ② FM band key
- ③ AM band key
- ④ LW band key [for BS, VS, ES]
- ⑤ Station keys
- ⑥ **+10** key
- ⑦ Preset Scan key (P. SCAN)
- ⑧ Memory write key (MEMORY)
- ⑨ FM mode key (FM MODE)
- ⑩ Tuning key (DOWN/UP)
- ⑪ Volume control (VOLUME)
- ⑫ Effect volume control (EFFECT VOLUME)
- ⑬ Source select switch (SOURCE)
- ⑭ Surround switch (SURROUND)
- ⑮ Tuner function key/indicator (TUNER)
- ⑯ Phono function key/indicator (PHONO)
- ⑰ CD/Aux function key/indicator (CD/AUX)
- ⑱ Tape monitor function key/indicator (TAPE MONITOR)
- ⑲ Video function key/indicator (VIDEO)
- ⑳ Balance control (BALANCE)
- ㉑ Graphic equalizer controls (GRAPHIC EQUALIZER)
- ㉒ Headphones jack (PHONES)
- ㉓ FM STEREO indicator
- ㉔ Frequency display
- ㉕ Memory indicator
- ㉖ Station display
- ㉗ FM mode "AUTO" indicator
- ㉘ Locked indicator
- ㉙ Ground terminal (GND)
- ㉚ Surround speaker terminals
- ㉛ Power supply cord
- ㉜ Main speaker terminals
- ㉝ Video input jacks
- ㉞ Tape play jacks
- ㉟ Tape rec jacks
- ㊱ CD/AUX input jacks
- ㊲ Phono input jacks
- ㊳ FM (75 ohms) antenna terminals
- ㊴ AM loop antenna terminals
- ㊵ AM external antenna terminals
- ㊶ FM (75 ohms) antenna terminals [except ZS]
- ㊷ AC output jack.
- ㊸ AM spacing selector [for EW]
- ㊹ Voltage selector [for EW]
- ㊺ Fuse holder [for EW]
- ㊻ AC outlet [for US, CS, EW]

- ① Netzschalter (POWER)
- ② UKW-Bandtaste (FM)
- ③ MW-Bandtaste (AM)
- ④ LW-Bandtaste (LW) [für BS, VS, ES]
- ⑤ Stationstasten
- ⑥ **+10** Taste
- ⑦ Speicherabtast-Taste (P. SCAN)
- ⑧ Speicherschreibtaste (MEMORY)
- ⑨ UKW-Empfangsarttaste (FM MODE)
- ⑩ Abstimmaste (DOWN/UP)
- ⑪ Lautstärkeregl. (VOLUME)
- ⑫ Effektlautstärkeregl. (EFFECT VOLUME)
- ⑬ Quellenwahlschalter (SOURCE)
- ⑭ Umfeldschalter (SURROUND)
- ⑮ Tuner-Funktionstaste/anzeig. (TUNER)
- ⑯ Plattenspieler-Funktionstaste/anzeig. (PHONO)
- ⑰ CD/Aux-Funktionstaste/anzeig. (CD/AUX)
- ⑱ Bandüberwachung-Funktionstaste/anzeig. (TAPE MONITOR)
- ⑲ Video-Funktionstaste/anzeig. (VIDEO)
- ⑳ Balanceregler (BALANCE)
- ㉑ Graphic-Equalizer-Regler (GRAPHIC EQUALIZER)
- ㉒ Kopfhörerbuchse (PHONES)
- ㉓ UKW-Stereoanzeige (FM STEREO)
- ㉔ Frequenzanzeige
- ㉕ Speicheranzeige
- ㉖ Stationsanzeige
- ㉗ UKW-Empfangsart-"AUTO"-Anzeige
- ㉘ Empfangs-Anzeige
- ㉙ Masseklemme (GND)
- ㉚ Umfeldlautsprecher-Anschlüsse
- ㉛ Netzkabel
- ㉜ Hauptlautsprecher-Anschlüsse
- ㉝ Video-Eingangsbuchse
- ㉞ Tonband-Wiedergabebuchsen
- ㉟ Tonband-Aufnahmebuchsen
- ㊱ CD/AUX-Eingangsbuchsen
- ㊲ Plattenspieler-Eingangsbuchsen
- ㊳ UKW-Antennenanschluß (75 Ohm)
- ㊴ MW-Rahmenantennen-Anschlüsse
- ㊵ MW-Außenantennen-Anschluß
- ㊶ UKW-Antennenanschlüsse (75 Ohm) [außer ZS]
- ㊷ Netzausgänge
- ㊸ AM-Kanalabstandswähler [für EW]
- ㊹ Spannungswähler [für EW]
- ㊺ Sicherungshalter [für EW]
- ㊻ Netzausgang [für US, CS, EW]

- ① Interrupteur d'alimentation (POWER)
- ② Touche de gamme FM
- ③ Touche de gamme AM
- ④ Touche de gamme GO (LW) [pour BS, VS, ES]
- ⑤ Touches de station
- ⑥ Touche **+10**
- ⑦ Touche de balayage des stations pré-réglées (P. SCAN)
- ⑧ Touche d'inscription en mémoire (MEMORY)
- ⑨ Touche de mode FM (FM MODE)
- ⑩ Touche d'accord (ascendante/descendante) (DOWN/UP)
- ⑪ Commande de volume (VOLUME)
- ⑫ Commande d'effet de volume (EFFECT VOLUME)
- ⑬ Commutateur de sélection de source (SOURCE)
- ⑭ Commutateur d'ambiance (SURROUND)
- ⑮ Touche de fonction/d'indicateur du syntonisateur (TUNER)
- ⑯ Touche de fonction/d'indicateur de la table de lecture (PHONO)
- ⑰ Touche de fonction/d'indicateur de lecteur de disque compact/composant auxiliaire (CD/AUX)
- ⑱ Touche de fonction/d'indicateur de contrôle de bande (TAPE MONITOR)
- ⑲ Commande de fonction/d'indicateur video (VIDEO)
- ⑳ Commande d'équilibrage (BALANCE)
- ㉑ Commandes d'égaliseur graphique (GRAPHIC EQUALIZER)
- ㉒ Prise de casque (PHONES)
- ㉓ Témoin FM STEREO
- ㉔ Affichage de fréquence
- ㉕ Témoin de mémoire
- ㉖ Affichage de Affichage de station
- ㉗ Témoin de mode FM automatique
- ㉘ Témoin de verrouillage
- ㉙ Borne de terre (GND)
- ㉚ Enceintes d'ambiance
- ㉛ Cordon d'alimentation
- ㉜ Bornes d'enceintes principales
- ㉝ Prises d'entrée vidéo
- ㉞ Prises de lecture de bande
- ㉟ Prises d'enregistrement de bande
- ㊱ Prises d'entrée CD/AUX
- ㊲ Prises d'entrée PHONO
- ㊳ Borne d'antenne FM (75 ohms)
- ㊴ Borne d'antenne-cadre AM
- ㊵ Borne d'antenne AM extérieure
- ㊶ Borne d'antenne FM (75 ohms) [sauf pour ZS]
- ㊷ Prise de sortie CA
- ㊸ Sélecteur despacement AM [pour EW]
- ㊹ Sélecteur de tension [pour EW]
- ㊺ Support de fusible [pour EW]
- ㊻ Sortie CA [pour US, CS, EW]

HTA-D30

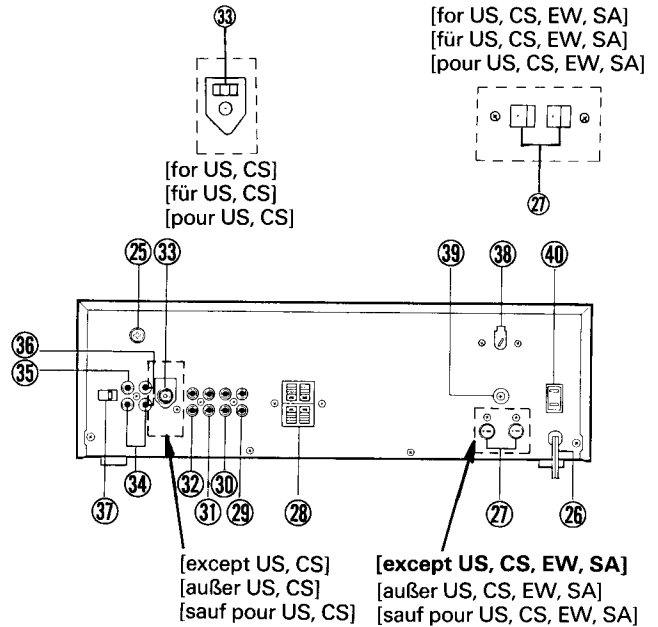
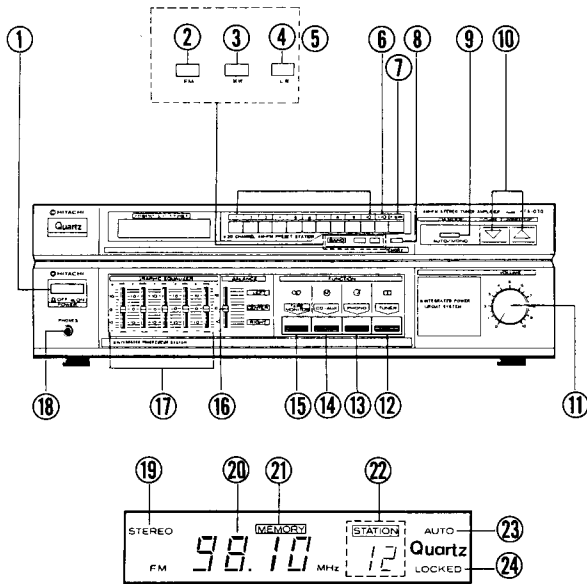

- ① Power switch (POWER)
- ② FM band key
- ③ AM band key
- ④ LW band key [for BS, VS, ES]
- ⑤ Station keys
- ⑥ **+10** key
- ⑦ Preset Scan key (P. SCAN)
- ⑧ Memory write key (MEMORY)
- ⑨ FM mode key (FM MODE)
- ⑩ Tuning key (DOWN/UP)
- ⑪ Volume control (VOLUME)
- ⑫ Tuner function key (TUNER)
- ⑬ Phono function key (PHONO)
- ⑭ CD/Aux function key (CD/AUX)
- ⑮ Tape monitor function key (TAPE MONITOR)
- ⑯ Balance control (BALANCE)
- ⑰ Graphic equalizer controls (GRAPHIC EQUALIZER)
- ⑱ Headphones jack (PHONES)
- ⑲ FM STEREO indicator
- ⑳ Frequency display
- ㉑ Memory indicator
- ㉒ Station display
- ㉓ FM mode "AUTO" indicator
- ㉔ Locked indicator
- ㉕ Ground terminal (GND)
- ㉖ Power supply cord
- ㉗ AC output jack
- ㉘ Speaker terminal
- ㉙ Tape play jack
- ㉚ Tape rec jack
- ㉛ CD/AUX input jacks
- ㉜ Phono input jack
- ㉝ FM (75 ohms) antenna jack
- ㉞ AM loop antenna terminals
- ㉟ FM (75 ohms) antenna terminals [except ZS]
- ㊱ AM spacing selector [for EW]
- ㊲ Voltage selector [for EW]
- ㊳ Fuse holder [for EW]
- ㊴ AC outlet [for US, CS, EW]

- ① Netzschalter (POWER)
- ② UKW-Bandtaste (FM)
- ③ MW-Bandtaste (AM)
- ④ LW-Bandtaste (LW) [für BS, VS, ES]
- ⑤ Stationstasten
- ⑥ **+10** Taste
- ⑦ Speicherabstast-Taste (P. SCAN)
- ⑧ Speicherschreibtaste (MEMORY)
- ⑨ UKW-Empfangsarttaste (FM MODE)
- ⑩ Abstimmaste (DOWN/UP)
- ⑪ Lautstärkeregl. (VOLUME)
- ⑫ Tuner-Funktionstaste (TUNER)
- ⑬ Plattenspieler-Funktionstaste (PHONO)
- ⑭ CD/Aux-Funktionstaste (CD/AUX)
- ⑮ Bandüberwachung-Funktionstaste (TAPE MONITOR)
- ⑯ Balanceregler (BALANCE)
- ⑰ Graphic-Equalizer-Regler (GRAPHIC EQUALIZER)
- ⑱ Kopfhörerbuchse (PHONES)
- ⑲ UKW-Stereoanzeige (FM STEREO)
- ⑳ Frequenzanzeige
- ㉑ Speicheranzeige
- ㉒ Stationsanzeige
- ㉓ UKW-Empfangsart-"AUTO"-Anzeige
- ㉔ Empfangs-Anzeige
- ㉕ Masseklemme (GND)
- ㉖ Netzkabel
- ㉗ Netzausgänge
- ㉘ Lautsprecheranschlüsse
- ㉙ Tonband-Wiedergabebuchsen
- ㉚ Tonband-Aufnahmebuchsen
- ㉛ CD/AUX-Eingangsbuchsen
- ㉜ Plattenspieler-Eingangsbuchsen
- ㉝ UKW-Antennenanschluß (75 Ohm)
- ㉞ MW-Rahmenantennen-Anschlüsse
- ㉟ MW-Außenantennen-Anschluß
- ㊱ UKW-Antennenanschlüsse (75 Ohm) [außer ZS]
- ㊲ AM-Kanalabstandswähler [für EW]
- ㊳ Spannungswähler [für EW]
- ㊴ Sicherungshalter [für EW]
- ㊵ Netzausgang [für US, CS, EW]

- ① Interrupteur d'alimentation (POWER)
- ② Touche de gamme FM
- ③ Touche de gamme AM
- ④ Touche de gamme GO (LW) [pour BS, VS, ES]
- ⑤ Touches de station
- ⑥ Touche **+10**
- ⑦ Touche de balayage des stations pré-réglées (P. SCAN)
- ⑧ Touche d'inscription en mémoire (MEMORY)
- ⑨ Touche de mode FM (FM MODE)
- ⑩ Touche d'accord (ascendante/descendante) (DOWN/UP)
- ⑪ Commande de volume (VOLUME)
- ⑫ Touch de fonction du syntonisateur (TUNER)
- ⑬ Touch de fonction de la table de lecture (PHONO)
- ⑭ Touche de fonction de lecteur de disque compact/composant auxiliaire (CD/AUX)
- ⑮ Touch de fonction de contrôle de bande (TAPE MONITOR)
- ⑯ Commande d'équilibrage (BALANCE)
- ⑰ Commandes d'égaliseur graphique (GRAPHIC EQUALIZER)
- ⑱ Pris de casque (PHONES)
- ⑲ Témoin FM STEREO
- ⑳ Affichage de fréquence
- ㉑ Témoin de mémoire
- ㉒ Affichage de station
- ㉓ Témoin de mode FM automatique
- ㉔ Témoin d'entrée verrouillage
- ㉕ Borne de terre
- ㉖ Cordon d'alimentation
- ㉗ Prise de sortie CA
- ㉘ Bornes d'enceintes
- ㉙ Prises de lecture de bande
- ㉚ Prises d'enregistrement de bande
- ㉛ Prises d'entrée CD/AUX
- ㉜ Prises d'entrée PHONO
- ㉝ Borne d'antenne FM (75 ohms)
- ㉞ Bornes d'antenne-cadre AM
- ㉟ Borne d'antenne AM extérieure
- ㊱ Bornes d'antenne FM (75 ohms) [sauf pour ZS]
- ㊲ Sélecteur despacement AM [pour EW]
- ㊳ Sélecteur de tension [pour EW]
- ㊴ Support de fusible [pour EW]
- ㊵ Sortie CA [pour US, CS, EW]

BLOCK DIAGRAM · BLOCKSCHEMA · SHEMA

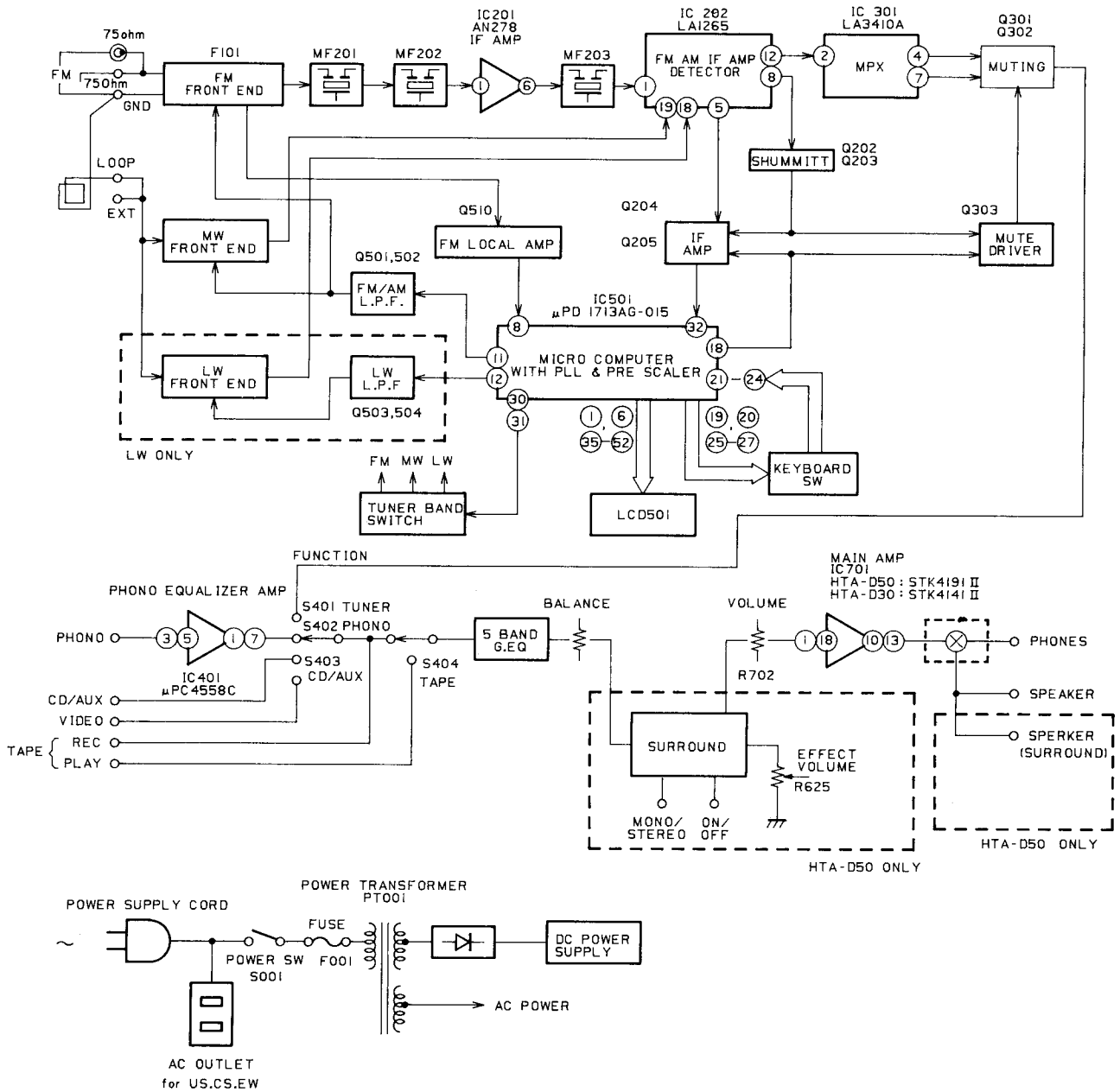

REPLACEMENT PARTS LIST · ERSATZTEILLISTE · TABLEAU DES PIECES

CD.....Ceramic discal EL..... Electrolytic ST..... Styrol ME..... Metal CO..... Composition ★..... HTA-D50 only
 CC..... Cylindrical ceramic MF..... Mylar, film CF..... Carbon film MO..... Metal, oxide FR..... Fuse resistor ○..... HTA-D30 only

SYMBOL NO.	PART NO.	DESCRIPTION	SYMBOL NO.	PART NO.	DESCRIPTION	SYMBOL NO.	PART NO.	DESCRIPTION
CAPACITORS								
△C001	1243901	CD 0.01μF +100%	C222	02441712	CD 0.01μF $\pm 20\%$	C411L,R	02086922	CD 220pF ± 5%
C101	02750152	MF 0.047μF ± 10% (except ZS)	C223	02441712	CD 0.01μF $\pm 20\%$			(for ZS)
C101	02760112	MF 0.1μF ± 10% (for ZS)	C224	02464462	CD 18pF ± 5%	C413	02441732	CD 0.022μF $\pm 80\%$
C102	02528112	EL 1μF (for ZS)	C225	0252521	EL 10μF	C415L,R	02097312	CD 1000pF ± 10% (for ZS)
C104	02441732	CD 0.022μF $\pm 20\%$	C226	1252532	EL 220μF	C416	02441712	CD 0.01μF $\pm 80\%$
C105	02086742	CD 39pF ± 5%	C227	0240108	CC 0.022μF ± 30%			(for ZS)
C106	02086742	CD 39pF ± 5% (for ZS)	C228	0240108	CC 0.022μF ± 30%	C417	02441712	CD 0.01μF $\pm 80\%$
C107	0230624	CC 33pF ± 5%	C229	02441712	CD 0.01μF $\pm 20\%$			(for ZS)
C108	0252802	EL 0.22μF (for ZS)	C230	02097332	CD 2200pF ± 10%	★C418L,R	02086922	CD 220pF ± 5%
C109	02441732	CD 0.022μF $\pm 80\%$	C231	0240053	CC 2200pF ± 20%			(for ZS)
C151	02441732	CD 0.022μF $\pm 80\%$	C232	02097332	CD 2200pF ± 10%	★C419	02522252	EL 47μF
C152	0240108	CC 0.022μF ± 30% (for ES,VS,BS)	C250	02464142	CD 4pF ± 0.25pF	★C420	02522252	EL 47μF
C153	02464542	CD 39pF ± 5% (for ES,VS,BS)	C301	02525312	EL 100μF	C421L,R	02097222	CD 390pF ± 10%
C154	02464262	CD 6pF ± 0.5% (except ES,VS,BS)	C302	02097242	CD 560pF ± 10%	C422L,R	02528132	EL 3.3μF
C154	02464302	CD 10pF ± 0.5% (for ES,VS,BS)	C303	0252521	EL 10μF	C423L,R	02097322	CD 1500pF ± 10%
C155	0228331	ST 270pF ± 5% (for ES,VS,BS)	C304	02528052	EL 0.47μF	C500	0252242	EL 2200pF
C158	0279326	PP 510pF ± 2%	C305	02528112	EL 1μF	C501	0230071	CC 24pF ± 5%
C159	02464652	CD 110pF ± 5% (for ES,VS,BS)	C306	0252521	EL 10μF	C502	0230071	CC 24pF ± 5%
C160	02464422	CD 12pF ± 5%	C307	02528112	EL 1μF	C503	02097332	CD 2200pF ± 10%
C161	02528112	EL 1μF (for ES,VS,BS)	C308	02086862	CD 120pF ± 5% (for ZS)	C504	0252802	EL 0.22μF
C162	02441732	CD 0.022μF $\pm 80\%$	C308	02097262	CD 820pF ± 10% (for US,CS)			(for ES,VS,BS)
C163	02441732	CD 0.022μF $\pm 80\%$	C308	02097212	CD 330pF ± 10% (except US,CS,VS,ZS)	C505	02528112	EL 1μF
C201	0240108	CC 0.022μF ± 30%	C308	02086942	CD 270pF ± 5% (for ZS)	C506	02750162	MF 0.068μF ± 10% (for ES,VS,BS)
C202	0240108	CC 0.022μF ± 30%	C309	02086862	CD 120pF ± 5% (for ZS)	C507	1252880	EL 4.7μF
C203	0240108	CC 0.022μF ± 30%	C309	02097262	CD 820pF ± 10% (for US,CS)	C508	02441732	CD 0.022μF $\pm 80\%$
C204	02528132	EL 3.3μF	C309	02097212	CD 330pF ± 10% (except US,CS,VS,ZS)	C509	02441732	CD 0.022μF $\pm 80\%$
C205	0240061	CC 0.01μF ± 30%	C309	02086942	CD 270pF ± 5% (for VS)	C510	02441732	CD 0.022μF $\pm 80\%$
C206	02086842	CD 100pF ± 5%	C310	02528112	EL 1μF	C511	02086722	CD 33pF ± 5%
C207	0252521	EL 10μF	C311	02528112	EL 1μF	C512	0208664	CD 15pF ± 5%
C208	02528132	EL 3.3μF	C312	02525312	EL 100μF	C513	02441712	CD 0.01μF $\pm 80\%$
C209	02086722	CD 33pF ± 5%	C313	02097332	CD 2200pF ± 10% (for VS,ZS)	C599	0252521	EL 10μF
C210	02441712	CD 0.01μF $\pm 20\%$	C314	02097332	CD 2200pF ± 10% (for VS,ZS)	★C601	02528132	EL 3.3μF
C211	02441712	CD 0.01μF $\pm 80\%$	C315	0240108	CC 0.022μF ± 30%	★C602	02528132	EL 3.3μF
C212	02740112	MF 1000pF ± 10%	C316	02528112	EL 1μF (for VS,ZS)	★C603	0275036	MF 0.082μF ± 10%
C213	0252521	EL 10μF	C317	0252521	EL 10μF	★C604	02097322	CD 1500pF ± 10%
C214	02528132	EL 3.3μF	C318	02528112	EL 1μF	★C605	02750162	MF 0.068μF ± 10%
C215	02528152	EL 4.7μF	C319	02528112	EL 1μF	★C606	0275032	MF 0.018μF ± 10%
C216	0275035	MF 0.056μF ± 10% (except VS,ZS)	C401L,R	02528112	EL 1μF	★C607	0275032	MF 0.018μF ± 10%
C216	02760112	MF 0.1μF ± 10% (for VS,ZS)	C402L,R	02097312	CD 1000pF ± 10% (for ZS)	★C608	02097322	CD 1500pF ± 10%
C217	02464562	CD 47pF ± 5%	C403L,R	0252225	EL 47μF	★C609	02097312	CD 1000pF ± 10%
C218	0252521	EL 10μF	C404L,R	0274236	MF 8200pF ± 5%	★C610	02528132	EL 3.3μF
C219	02441732	CD 0.022μF $\pm 80\%$	C405L,R	02097332	CD 2200pF ± 10%	★C611	02097322	CD 1500pF ± 10%
C220	0252521	EL 10μF	C406L,R	02086942	CD 270pF ± 5%	★C612	0252521	EL 10μF
C221	02750152	MF 0.047μF ± 10%	C407L,R	02528122	EL 2.2μF	★C613	0252521	EL 10μF
			C408	0252521	EL 10μF	C701L,R	02097242	CD 560pF ± 10%
			C409	0252521	EL 10μF	C702L,R	02528132	EL 3.3μF
			★C410L,R	02097232	CD 470pF ± 10% (for ZS)	○C703L,R	02086882	CD 150pF ± 5%
			○C410L,R	02086922	CD 220pF ± 5% (for ZS)	★C703L,R	02086882	CD 150pF ± 5% (except ZS)
						★C703L,R	0208682	CD 82pF ± 5% (for ZS)
						C704L,R	0208633	CD 3pF ± 0.25pF
						C705L,R	02528252	EL 47μF
						C706	02528212	EL 10μF
						C707L,R	02522312	EL 100μF
						○C708L,R	02097212	CD 330pF ± 10%
						★C708L,R	02097212	CD 330pF ± 10% (except ZS)
						★C708L,R	02097312	CD 1000pF ± 10% (for ZS)

SYMBOL NO.	PART NO.	DESCRIPTION
C710	1276511	MF 0.1 μ F \pm 10% 100V (except ZS)
○ C710	1276511	MF 0.1 μ F \pm 10% 100V
○ C711	0275011	MF 0.01 μ F \pm 10% 50V (for ZS)
C712	02528212	EL 10 μ F 50V
C713	02760112	MF 0.1 μ F \pm 10% 50V (except ZS)
C714	1252831	EL 100 μ F 50V
C715L,R	02750152	MF 0.047 μ F \pm 10% 50V (except BS)
○ C715R	02760112	MF 0.1 μ F \pm 10% 50V (for BS)
		MF 0.1 μ F \pm 10% 50V (for BS)
C716L,R	0240045	CC 1000pF \pm 10% 50V (for ZS)
C717L,R	0275013	MF 0.022 μ F \pm 10% 50V (for ZS)
C718L,R	02441712	CD 0.01 μ F \pm 80% -20% 50V (for ZS)
★ C719L,R	02740142	MF 3300pF \pm 10% 50V (for ZS)
C720L,R	02760112	MF 0.1 μ F \pm 10% 50V (for BS)
C721	02760112	MF 0.1 μ F \pm 10% 50V (for BS)
★ C750L,R	02441732	CD 0.022 μ F \pm 80% -20% 50V (for ZS)
★ C751L,R	02441732	CD 0.022 μ F \pm 80% -20% 50V (for ZS)
★ C801	0259931	EL 6800 μ F 50V
○ C801	0259933	EL 5600 μ F 40V
★ C802	0259931	EL 6800 μ F 50V
○ C802	0259933	EL 5600 μ F 50V
C803	02526252	EL 47 μ F 25V
C804	02526212	EL 10 μ F 25V
C805	02528132	EL 3.3 μ F 50V
C806	02528112	EL 1 μ F 50V
C807	02528122	EL 2.2 μ F 50V
C808	02528222	EL 22 μ F 50V
C809	0252521	EL 10 μ F 16V
★ C850	02441732	CD 0.022 μ F \pm 80% -20% 50V (for ZS)
○ C850	02760112	MF 0.1 μ F \pm 10% 50V (for ZS)
★ C860	02441732	CD 0.022 μ F \pm 80% -20% 50V (for ZS)
★ C861	02441732	CD 0.022 μ F \pm 80% -20% 50V (for ZS)
C890	0245408	CD 0.01 μ F \pm 20% 500V
C891	0245408	CD 0.01 μ F \pm 20% 500V
C892	1276511	MF 0.1 μ F \pm 10% 100V
C901	02528112	EL 1 μ F 50V
C902	0252521	EL 10 μ F 16V
RESISTORS		
△ R001	01390052	CO 2.7M Ω \pm 10% RC1/2GF (for US,CS)
R102	0113625	CF 2.7k Ω \pm 5% SRD1/6P
R105	0113663	CF 100k Ω \pm 5% SRD1/6P
R106	0113617	CF 1.2k Ω \pm 5% SRD1/6P (for ZS)
R107	0113663	CF 100k Ω \pm 5% SRD1/6P (for ZS)

SYMBOL NO.	PART NO.	DESCRIPTION
△ R108	1123619	CF 68 Ω \pm 5% SRD1/4P (for ZS)
△ R108	1123623	CF 150 Ω \pm 5% SRD1/4P (except ZS)
R109	0113663	CF 100k Ω \pm 5% SRD1/6P (for ZS)
R110	0113639	CF 10k Ω \pm 5% SRD1/6P (for ZS)
R111	0113591	CF 100 Ω \pm 5% SRD1/6P (for ZS)
R151	0113639	CF 10k Ω \pm 5% SRD1/6P
R152	0113639	CF 10k Ω \pm 5% SRD1/6P (for ES,VS,BS)
R155	0113671	CF 220k Ω \pm 5% SRD1/6P
R156	0113671	CF 220k Ω \pm 5% SRD1/6P (for ES,VS,BS)
R157	0113639	CF 10k Ω \pm 5% SRD1/6P (for ES,VS,BS)
R158	0113663	CF 100k Ω \pm 5% SRD1/6P (for ES,VS,BS)
R160	0113631	CF 4.7k Ω \pm 5% SRD1/6P (for ES,VS,BS)
R161	01133652	CF 1k Ω \pm 5% SRD1/2P
R162	0113623	CF 2.2k Ω \pm 5% SRD1/6P (for ES,VS,BS)
R201	0113603	CF 330 Ω \pm 5% SRD1/6P
R202	0113619	CF 1.5k Ω \pm 5% SRD1/6P
R203	0113619	CF 1.5k Ω \pm 5% SRD1/6P
R204	0113639	CF 10k Ω \pm 5% SRD1/6P
△ R205	1123624	CF 180 Ω \pm 5% SRD1/4P
R206	0113591	CF 100 Ω \pm 5% SRD1/6P
R209	0113637	CF 8.2k Ω \pm 5% SRD1/6P (for VS,ZS)
R209	0113645	CF 18k Ω \pm 5% SRD1/6P (except VS,ZS)
R210	0113639	CF 10k Ω \pm 5% SRD1/6P (for VS,ZS)
R210	0113647	CF 22k Ω \pm 5% SRD1/6P (except VS,ZS)
R211	0113591	CF 100 Ω \pm 5% SRD1/6P
R212	0113633	CF 5.6k Ω \pm 5% SRD1/6P
R213	0113647	CF 22k Ω \pm 5% SRD1/6P
R214	0113639	CF 10k Ω \pm 5% SRD1/6P
R215	0113655	CF 47k Ω \pm 5% SRD1/6P
R216	0113637	CF 8.2k Ω \pm 5% SRD1/6P (for US,CS)
R216	0113639	CF 10k Ω \pm 5% SRD1/6P (except US,CS)
R217	0113639	CF 10k Ω \pm 5% SRD1/6P
R218	0113639	CF 10k Ω \pm 5% SRD1/6P
R219	0113627	CF 3.3k Ω \pm 5% SRD1/6P
R220	0113663	CF 100k Ω \pm 5% SRD1/6P
R221	0113663	CF 100k Ω \pm 5% SRD1/6P
R222	0113637	CF 8.2k Ω \pm 5% SRD1/6P
R223	0113639	CF 10k Ω \pm 5% SRD1/6P
R224	0113615	CF 1k Ω \pm 5% SRD1/6P
R225	0113639	CF 10k Ω \pm 5% SRD1/6P
R226	0113659	CF 68k Ω \pm 5% SRD1/6P
R227	0113601	CF 270 Ω \pm 5% SRD1/6P
R228	0113615	CF 1k Ω \pm 5% SRD1/6P
R229	0113605	CF 390 Ω \pm 5% SRD1/6P
R231	0113659	CF 68k Ω \pm 5% SRD1/6P
R232	0113661	CF 82k Ω \pm 5% SRD1/6P
R233	0113631	CF 4.7k Ω \pm 5% SRD1/6P
R234	0113649	CF 27k Ω \pm 5% SRD1/6P
R235	0113607	CF 470 Ω \pm 5% SRD1/6P
R236	0113609	CF 560 Ω \pm 5% SRD1/6P

SYMBOL NO.	PART NO.	DESCRIPTION
R237	0113665	CF 120k Ω \pm 5% SRD1/6P
△ R301	1123621	CF 100 Ω \pm 5% SRD1/4P
R302	0113627	CF 3.3k Ω \pm 5% SRD1/6P
R303	0113653	CF 39k Ω \pm 5% SRD1/6P
R304	0113661	CF 82k Ω \pm 5% SRD1/6P (for US,CS)
R304	0113665	CF 120k Ω \pm 5% SRD1/6P (except US,CS,VS,ZS)
R304	0113667	CF 150k Ω \pm 5% SRD1/6P (for VS,ZS)
R305	0113661	CF 82k Ω \pm 5% SRD1/6P (for US,CS)
R305	0113665	CF 120k Ω \pm 5% SRD1/6P (except US,CS,VS,ZS)
R305	0113667	CF 150k Ω \pm 5% SRD1/6P (for VS,ZS)
R307	0113627	CF 3.3k Ω \pm 5% SRD1/6P
R308	0113627	CF 3.3k Ω \pm 5% SRD1/6P
R309	0113633	CF 5.6k Ω \pm 5% SRD1/6P
R310	0113633	CF 5.6k Ω \pm 5% SRD1/6P
R311	0113663	CF 100k Ω \pm 5% SRD1/6P
R312	0113663	CF 100k Ω \pm 5% SRD1/6P
R313	0113655	CF 47k Ω \pm 5% SRD1/6P (for VS,ZS)
R314	0113663	CF 100k Ω \pm 5% SRD1/6P
R315	0113623	CF 2.2k Ω \pm 5% SRD1/6P
R316	0113651	CF 33k Ω \pm 5% SRD1/6P
R317	0113615	CF 1k Ω \pm 5% SRD1/6P
R318	0113627	CF 3.3k Ω \pm 5% SRD1/6P (for VS,ZS)
R318	0113629	CF 3.9k Ω \pm 5% SRD1/6P (except VS,ZS)
R319	0113665	CF 120k Ω \pm 5% SRD1/6P
R320	0113663	CF 100k Ω \pm 5% SRD1/6P
R321	0113663	CF 100k Ω \pm 5% SRD1/6P
R401L,R	0113623	CF 2.2k Ω \pm 5% SRD1/6P
R402L,R	0113655	CF 4.7k Ω \pm 5% SRD1/6P
R403L,R	0113611	CF 680 Ω \pm 5% SRD1/6P
R404L,R	0113677	CF 390k Ω \pm 5% SRD1/6P
R405L,R	0113651	CF 33k Ω \pm 5% SRD1/6P
R406L,R	0113661	CF 82k Ω \pm 5% SRD1/6P
R407L,R	0113615	CF 1k Ω \pm 5% SRD1/6P
R408	0113631	CF 4.7k Ω \pm 5% SRD1/6P
R409L,R	0113615	CF 1k Ω \pm 5% SRD1/6P
R410L,R	0113615	CF 1k Ω \pm 5% SRD1/6P
★ R411	0129601	CF 1k Ω \pm 5% SRD1/4P
★ R412	0129601	CF 1k Ω \pm 5% SRD1/4P
R413L,R	0113615	CF 1k Ω \pm 5% SRD1/6P (for ZS)
★ R414L,R	0113615	CF 1k Ω \pm 5% SRD1/6P
R415L,R	0113663	CF 100k Ω \pm 5% SRD1/6P
★ R416	0113607	CF 470 Ω \pm 5% SRD1/6P
★ R417	0113607	CF 470 Ω \pm 5% SRD1/6P
R418L,R	0113663	CF 100k Ω \pm 5% SRD1/6P
R501	0113635	CF 6.8k Ω \pm 5% SRD1/6P
R502	0113623	CF 2.2k Ω \pm 5% SRD1/6P
R503	0113611	CF 680 Ω \pm 5% SRD1/6P
R504	0113631	CF 4.7k Ω \pm 5% SRD1/6P
R505	0113635	CF 6.8k Ω \pm 5% SRD1/6P (for ES,VS,BS)
R506	0113639	CF 10k Ω \pm 5% SRD1/6P (for ES,VS,BS)
R507	0113615	CF 1k Ω \pm 5% SRD1/6P (for ES,VS,BS)
R508	0113635	CF 6.8k Ω \pm 5% SRD1/6P (for ES,VS,BS)
R509	0113623	CF 2.2k Ω \pm 5% SRD1/6P

SYMBOL NO.	PART NO.	DESCRIPTION
R510	0113623	CF 2.2kΩ ±5% SRD1/6P
R511	0113659	CF 68kΩ ±5% SRD1/6P
R512	0113623	CF 2.2kΩ ±5% SRD1/6P
R513	0113655	CF 47kΩ ±5% SRD1/6P
R514	0113655	CF 47kΩ ±5% SRD1/6P
R515	0113655	CF 47kΩ ±5% SRD1/6P
R516	0113653	CF 39kΩ ±5% SRD1/6P
R517	0113653	CF 39kΩ ±5% SRD1/6P
R518	0113653	CF 39kΩ ±5% SRD1/6P
R519	0113653	CF 39kΩ ±5% SRD1/6P
R520	0113653	CF 39kΩ ±5% SRD1/6P
R521	0113653	CF 39kΩ ±5% SRD1/6P
R522	0113639	CF 10kΩ ±5% SRD1/6P
R524	0113663	CF 100kΩ ±5% SRD1/6P (for EW)
R525	0113655	CF 47kΩ ±5% SRD1/6P (for EW)
R526	0113639	CF 10kΩ ±5% SRD1/6P (for EW)
R528	0113639	CF 10kΩ ±5% SRD1/6P
R529	0113639	CF 10kΩ ±5% SRD1/6P (for ES,VS,BS)
R530	0113639	CF 10kΩ ±5% SRD1/6P
R531	0113639	CF 10kΩ ±5% SRD1/6P
R532	0113639	CF 10kΩ ±5% SRD1/6P
R533	0113639	CF 10kΩ ±5% SRD1/6P
R534	0113639	CF 10kΩ ±5% SRD1/6P
R538	0113663	CF 100kΩ ±5% SRD1/6P
R539	0113623	CF 2.2kΩ ±5% SRD1/6P
R540	0113615	CF 1kΩ ±5% SRD1/6P
R550	0113639	CF 10kΩ ±5% SRD1/6P (for EW)
★R601L,R	0113649	CF 27kΩ ±5% SRD1/6P
★R602	0113679	CF 470kΩ ±5% SRD1/6P
★R603	0113641	CF 12kΩ ±5% SRD1/6P
★R604	0113679	CF 470kΩ ±5% SRD1/6P
★R605	0113615	CF 1kΩ ±5% SRD1/6P
★R606	0113639	CF 10kΩ ±5% SRD1/6P
★R607L,R	0113649	CF 27kΩ ±5% SRD1/6P
★R608	0113641	CF 12kΩ ±5% SRD1/6P
★R609	0113653	CF 39kΩ ±5% SRD1/6P
★R610	0113653	CF 39kΩ ±5% SRD1/6P
★R611	0113647	CF 22kΩ ±5% SRD1/6P
★R612	0113647	CF 22kΩ ±5% SRD1/6P
★R613	0113647	CF 22kΩ ±5% SRD1/6P
★R614	0113663	CF 100kΩ ±5% SRD1/6P
★R615	0113647	CF 22kΩ ±5% SRD1/6P
★R616	0113647	CF 22kΩ ±5% SRD1/6P
★R617	0113647	CF 22kΩ ±5% SRD1/6P
★R618	0113647	CF 22kΩ ±5% SRD1/6P
★R619	0113647	CF 22kΩ ±5% SRD1/6P
★R620	0113647	CF 22kΩ ±5% SRD1/6P
★R621	0113647	CF 22kΩ ±5% SRD1/6P
★R622	0113647	CF 22kΩ ±5% SRD1/6P
★R623	0113647	CF 22kΩ ±5% SRD1/6P
★R624	0113639	CF 10kΩ ±5% SRD1/6P
★R626	0113639	CF 10kΩ ±5% SRD1/6P
★R627	0113639	CF 10kΩ ±5% SRD1/6P
★R628	0113639	CF 10kΩ ±5% SRD1/6P
R703L,R	0113623	CF 2.2kΩ ±5% SRD1/6P
R704L,R	0113661	CF 82kΩ ±5% SRD1/6P
★R705L,R	0113609	CF 560Ω ±5% SRD1/6P
○R705L,R	0113611	CF 680Ω ±5% SRD1/6P
R706L,R	0113661	CF 82kΩ ±5% SRD1/6P
R707L,R	0129609	CF 2.2kΩ ±5% SRD1/4P
R708L,R	0129609	CF 2.2kΩ ±5% SRD1/4P
△R709	1110621	FR 100Ω ±5% RN1/4B

SYMBOL NO.	PART NO.	DESCRIPTION
R710	0129579	CF 560Ω ±5% SRD1/4P
R711	0129635	CF 15kΩ ±5% SRD1/4P
R712	0113655	CF 47kΩ ±5% SRD1/6P
△R713	1110605	FR 22Ω ±5% RN1/4B
R714L,R	0129531	CF 10Ω ±5% SRD1/4P
R715L	1119029	ME 4.7Ω ±10% RN1B
R715R	1119029	ME 4.7Ω ±10% RN1B (except BS)
★R716L,R	01132972	CF 680Ω ±5% SRD1/2P
○R716L,R	0113293	CF 330Ω ±5% SRD1/2P
R720	1119029	ME 4.7Ω ±10% RN1B (for BS)
★R721L,R	01132972	CF 680Ω ±5% SRD1/2P
★R801	1119158	ME 39Ω ±10% RN2B
○R801	1119151	ME 10Ω ±10% RN2B
★R802	1119158	ME 39Ω ±10% RN2B
○R802	1119142	ME 8.2Ω ±10% RN2B
★R803	1113825	FR 4.7Ω ±5% RN1/2B
△○R803	1113824	FR 3.9Ω ±5% RN1/2B
○R804	0129615	CF 3.9kΩ ±5% SRD1/4P
★R804	0129631	CF 10kΩ ±5% SRD1/4P
R805	0113615	CF 1kΩ ±5% SRD1/6P
△R806	1110625	FR 220Ω ±5% RN1/4B
R807	0129617	CF 4.7kΩ ±5% SRD1/4P
R808	0113615	CF 1kΩ ±5% SRD1/6P
R809	01132872	CF 100Ω ±5% SRD1/2P
R810	01132872	CF 100Ω ±5% SRD1/2P
R811	0129613	CF 3.3kΩ ±5% SRD1/4P
R812	0113631	CF 4.7kΩ ±5% SRD1/6P
R813	0113647	CF 22kΩ ±5% SRD1/6P
R814	0113591	CF 100Ω ±5% SRD1/6P
R815	0113657	CF 56kΩ ±5% SRD1/6P
R816	0113663	CF 100kΩ ±5% SRD1/6P
★R817	1119158	ME 39Ω ±10% RN2B
★R818	1119158	ME 39Ω ±10% RN2B
R901	0113657	CF 56kΩ ±5% SRD1/6P
R902	0113575	CF 22Ω ±5% SRD1/6P
R903	0113615	CF 1kΩ ±5% SRD1/6P
R904	0113663	CF 100kΩ ±5% SRD1/6P (for ES,VS,BS)
R906	0113655	CF 47kΩ ±5% SRD1/6P (for ZS)
R906	0113663	CF 100kΩ ±5% SRD1/6P (except ZS)
R913	0113613	CF 820Ω ±5% SRD1/6P (for ZS)
R913	0113623	CF 2.2kΩ ±5% SRD1/6P (except ZS)
R914	01132222	CF 27Ω ±5% SRD1/2P
ICS AND TRANSISTORS		
IC201	23684312	AN278
IC202	2300411	LA1265
IC301	2388941	LA3410A
IC401	2300831	μPC4558C
IC402	2300831	μPC4558C
IC501	2300861	μPD1713AG-015
IC502	2387611	BA6251
★IC601	2300831	μPC4558C
★IC602	2300831	μPC4558C
★IC603	2300831	μPC4558C
★IC604	2300831	μPC4558C
★IC701	2387491	STK4191 II
○IC701	2387531	STK4141 II
Q101	2328803	2SK104 (H) (for ZS)
Q102	2328285	2SC458PG (C) (for ZS)

SYMBOL NO.	PART NO.	DESCRIPTION
Q151	2328285	2SC458PG (C) (for ES,VS,BS)
Q152	2328285	2SC458PG (C) (for ES,VS,BS)
Q201	2328285	2SC458PG (C)
Q202	2328285	2SC458PG (C)
Q203	2328285	2SC458PG (C)
Q204	05734862	2SC460 (B)
Q205	2328285	2SC458PG (C)
Q301	2328285	2SC458PG (C)
Q302	2328285	2SC458PG (C)
Q303	2329183	2SA1015 (GR)
Q304	2328285	2SC458PG (C)
Q501	2328285	2SC458PG (C)
Q502	2328285	2SC458PG (C)
Q503	2328285	2SC458PG (C) (for ES,VS,BS)
Q504	2328285	2SC458PG (C) (for ES,VS,BS)
Q505	2329183	2SA1015 (GR)
Q506	2329183	2SA1015 (GR) (for EW)
Q507	2328285	2SC458PG (C) (for EW)
Q508	2329183	2SA1015 (GR)
Q509	2328285	2SC458PG (C)
Q510	05734862	2SC460 (B)
Q801	2317822	2SD880 (V)
★Q802	2328625	2SB647 (C)
○Q802	2329133	2SA1015 (GR)
Q803	2328285	2SC458PG (C)
Q804	2328285	2SC458PG (C)
Q901	2329183	2SA1015 (GR)
Q902	2329183	2SA1015 (GR) (for ES,VS,BS)
Q903	2329183	2SA1015 (GR) (for ES,VS,BS)
Q904	2329183	2SA1015 (GR)
Q905	2329183	2SA1015 (GR)
DIODE		
D101	2398082	1N4148
D102	2398082	1N4148
D103	2337931	1K60R (for ZS)
D104	2337931	1K60R (for ZS)
D151	2398082	1N4148
D152	2398082	1N4148
D153	2397321	KV1260
D154	2397321	KV1260 (for ES,VS,BS)
D155	2398082	1N4148 (for ES,VS,BS)
}	}	}
D159	2398082	1N4148 (for ES,VS,BS)
D201	2398082	1N4148
D250	2398081	1N4148
D301	2398082	1N4148
D302	2398082	1N4148
★D401	2339104	SLP-660C
★D402	2339104	SLP-660C
★D403	2339104	SLP-660C
★D404	2339104	SLP-660C
★D405	2339104	SLP-660C
D501	2398082	1N4148
}	}	}
D510	2398082	1N4148
D511	2398082	1N4148 (except US,CS)
D512	2398082	1N4148 (except US,CS)
D512	2398081	1N4148 (for US,CS)
D513	2398082	1N4148
D514	2398082	1N4148
D515	2398081	1N4148
D516	2337292	HZ-9B
D801	2337461	S4VB20
D805	2339001	DS135D
D806	2337151	1S2076A

HITACHI HTA-D50/D30

SYMBOL NO.	PART NO.	DESCRIPTION
D807	2398082	1N4148
D808	2337587	HZ5C1
D809	2337189	HZ-15-3
D810	2337189	HZ-15-3
D811	2337122	HZ-6B
D812	2398082	1N4148
D901	2398082	1N4148
D902	2398082	1N4148
VARIABLE RESISTORS		
★ R625	0158744	10kΩ- (B) EFFECT VOL.
R702	0158739	100kΩ- (D) MAIN VOL.
COILS AND TRANSFORMERS		
L151	2136503	MW antenna coil
L152	2136504	LW antenna coil (for ES,VS,BS)
L153	2136493	MW OSC coil
L154	2136494	LW OSC coil (for ES,VS,BS)
L201	2227915	Choke coil 4.7μH
L701L,R	2227361	Audio trap coil 0.67μ
MISCELLANEOUS		
△ S001	2600151	Push switch POWER
S002	2618053	Voltage switch VOLTAGE SELECTOR (for EW)
S003	2628301	Slide switch AM CHANNEL SPACING (for EW)
★ S401	2600442	5 Key push switch (FUNCTION)
★ S405		
○ S401	2600441	4 Key push switch (FUNCTION)
○ S404		
S501	2639682	Tact switch P1
S502	2639682	Tact switch P2
S503	2639682	Tact switch P3
S504	2639682	Tact switch P4
S505	2638241	Tact switch FM MODE
S506	2639683	Tact switch FM
S507	2639682	Tact switch P5
S508	2639682	Tact switch P6
S509	2639682	Tact switch P7
S510	2639682	Tact switch P8
S511	2639683	Tact switch MEMO
S512	2639683	Tact switch MW
S513	2639682	Tact switch P9
S514	2639682	Tact switch P10
S515	2639683	Tact switch UP
S516	2639683	Tact switch DOWN
S517	2639682	Tact switch +10
S518	2639683	Tact switch LW (for ES,VS,BS)
S519	2639682	Tact switch P.SCAN
★ S601	2600431	2 Key push switch SURROUND, SOURCE
★ S602		
X301	2136661	Ceramic filter
X501	2789281	Crystal oscillator

SYMBOL NO.	PART NO.	DESCRIPTION
MF201	2135002	Ceramic filter
MF202	2135002	Ceramic filter
MF203	2135002	Ceramic filter
MF204	2155152	AM ceramic filter
MF205	2137212	Ceramic disc transformer
CP101	2136941	Filter, band pass (for VS,ZS)
CP301	2136313	Filter low pass (for VS,ZS)
CP302	2136311	Rack filter (for VS)
CP303	2136311	Rack filter (for VS)
△★ F001	2727962	Fuse 3A 125V (for US,CS)
△○ F001	2727964	Fuse 2.5A 125V (for US,CS)
△★ F001	2727194	Fuse T1.6A (except US,CS,EW)
△○ F001	2727191	Fuse T1A (except US,CS,EW)
△ F002	2727961	Fuse 2A 125V (for US,CS)
△ F002	2727193	Fuse T2A (except US,CS)
F101	2425461	Tuner pack (except ZS)
F101	2425561	Tuner pack (for ZS)
△ J001	2658711	Jack, power (except US,CS,SA,EW)
△ J002	2658711	Jack, power (except US,CS,SA,EW)
J003	2657831	Speaker socket (for US,CS,EW,SA)
C905	0259891	Capacitor 0.022F
	2780081	Liquid crystal display
	3801281	Holder, liquid crystal display
★	3801271	Holder, LED
★	2504811	TA PWB assembly (for US,CS)
★	2504812	TA PWB assembly (for ES)
★	2504813	TA PWB assembly (for VS)
★	2504814	TA PWB assembly (for KS)
★	2504815	TA PWB assembly (for BS)
★	2504816	TA PWB assembly (for SA)
★	2504817	TA PWB assembly (for EW)
★	2504818	TA PWB assembly (for ZS)
○	2504801	TA PWB assembly (for US,CS)
○	2504802	TA PWB assembly (for ES)
○	2504803	TA PWB assembly (for VS)
○	2504804	TA PWB assembly (for KS)
○	2504805	TA PWB assembly (for BS)
○	2504806	TA PWB assembly (for SA)
○	2504807	TA PWB assembly (for EW)
○	2504808	TA PWB assembly (for ZS)
	2678347	6P US-pin jack
	2678348	4P US-pin jack (except ZS)
	2678494	Socket, speaker
	2689383	4P speaker terminal
	2727681	Holder, fuse (for US, CS, SA, EW)
	4468352	Sheet, lamp filter
	2689541	4P antenna terminal (for US, CS)
	2689542	4P antenna terminal (for EW)
	2689543	4P antenna terminal (for ZS)
	2678561	4P US pin jack (for ZS)
for ACCESSORIES		
	2757528	FM antenna
	2758341	AM loop antenna

SYMBOL NO.	PART NO.	DESCRIPTION
	3637792	Antenna holder assembly
△★ F001	2727196	Fuse T3.15A 250V (for EW)
△○ F001	2727199	Fuse T2.5A 250V (for EW)
	2667922	Siemens plug (for EW)
FINAL ASSEMBLY		
★	4040333	Front panel assembly (for ES,VS,BS)
★	4040334	Front panel assembly (except ES,VS,BS)
○	4040331	Front panel assembly (for ES,VS,BS)
○	4040332	Front panel assembly (except ES,VS,BS)
	3801141	Function button
★	3299653	14 knob balance
★	3291642	Push knob (S)
	3307023	Knob (35) assembly
	3306531	Tact button (3x16)
	3297795	Power button (BC)
	4463922	Cover assembly
	3916411	Leg
	4747043	Felt, Leg
△★ PT001	2249361	Power transformer (120V) (for US)
△★ PT001	2249362	Power transformer (220V) (for KS,ZS,ES,VS)
△★ PT001	2249363	Power transformer (240V) (for SA,BS)
△★ PT001	2249364	Power transformer (120V, 220V, 240V) (for EW)
△★ PT001	2249365	Power transformer (120V) (for CS)
△○ PT001	2249351	Power transformer (120V) (for US,CS)
△○ PT001	2249352	Power transformer (220V) (for KS,ZS,ES,VS)
△○ PT001	2249353	Power transformer (240V) (for SA,BS)
△○ PT001	2249354	Power transformer (120V, 220V, 240V) (for EW)
	4567443	Screw, bind head 4 x 10
	4567422	Screw, bind head 4 x 8
	4567432	Screw, tapping bind head 3 x 8 (BC)
	86914102	Screw, 3 x 10 BT bind head
	4567413	Screw bind head 3 x 10
	4567451	3φx6 BT bind screw (SI)
	4784106	Screw, tapping bind head 3 x 10
	4567412	Screw, 3 x 8 DT Bind head
★	2377661	Module graphic-equalizer
	2767761	Lamp assembly (with wire)
REAR PLATE ASSEMBLY		
★	4468074	Rear plate (for US,CS)
★	4468075	Rear plate (for EW)
★	4468076	Rear plate (except US,CS,EW,SA)
	4468078	Rear plate (for SA)
○	4468071	Rear plate (for US,CS)
○	4468072	Rear plate (for EW)
○	4468073	Rear plate (except US,CS,EW,SA)

SYMBOL NO.	PART NO.	DESCRIPTION
○	4468077	Rear plate (for SA)
	4408861	Washer
△	0043793	Bushing (for EW)
△	3913006	Bushing (except EW)
△	2702711	Power supply cord (for US,CS)
△	2718091	Power supply cord (for KS,ZS,ES,VS)
△	2749582	Power supply cord (for BS)
△	2749622	Power supply cord (for SA)
△	2718113	Power supply cord (for EW)
△	2658372	AC outlet (for US,CS,EW)
	2727671	Fuse holder (for EW)
	4575661	Earth screw

Check that exposed parts are acceptably insulated from the supply circuit before returning the instrument repaired to the customer.

● **Checking method**

Power switch is set to ON.

Next, measure the resistance value between the both poles of attachment cup (Power supply plug) and the exposed parts (Parts such as Ground terminal, Knob, Cover, etc. where the customer is easy to touch) and check that the resistance value is 500 kohms or more.

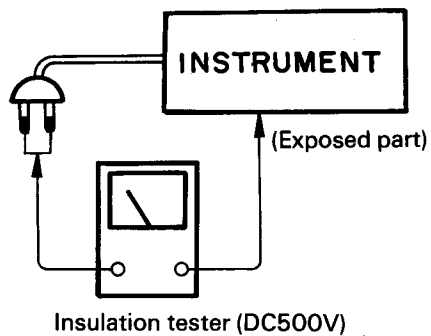



HITACHI SALES EUROPA GmbH
Postfach 801060 Rungedamm 2, 2050 Hamburg 80,
West Germany
Tel. 040-734 11-0

HITACHI SALES (U.K.) Ltd.
Hitachi House, Station Road, Hayes, Middlesex UB3
4DR, England
Tel. 01-848-8787

HITACHI SALES SCANDINAVIA AB
Rissneleden 8, Box 7138, 172-07 Sundbyberg, Sweden
Tel. 08-98 52 80

HITACHI SALES NORWAY A/S
Oerebekk 1620, Gressvik, P.O. Box 46, N-1601,
Fredrikstad, Norway
Tel. 032-28255

SUOMEN HITACHI OY
Takojanokatu 5, 15800 Lahti 80, Finland
Tel. Lahti 44 241

HITACHI SALES A/S
Kuldysen 13, DK-2630, Taastrup, Denmark
Tel. 02-999200

HITACHI SALES A.G.
Bahnhofstrasse, 19, 5600 Lenzburg, Switzerland
Tel. 064-513621

HITACHI SALES WARENHANDELS GMBH
A-1180/Wien, Kreuzgasse 27, Austria
Tel. 0222-439367

HITACHI SALES ITALIANA, S.P.A.
Via Cristoforo Colombo 49, Trezzano sul naviglio
(Milano), Italy
Tel. 02-44 59 031

HITACHI SALES BELGIUM S.A.
56, Chaussee de Namur B-1400 Nivelles, Belgium
Tel. (003267) 227181

HITACHI SALES IBERICA, S.A.
Gran Via Carlos Tercero, 101, 1-1, Barcelona-28,
Spain
Tel. 330-8652

HITACHI MAROC (RADIO TV ELECTRO-MANAGER), S.A.
Rue du Havre, Casablanca, Morocco
Tel. 30-73-68, 30-73-57

HITACHI CANARIAS S.A.
Calle San-Francisco No. 19, Santa Cruz de Tenerife
Canary Islands
Tel. 24-64-98

HITACHI SALES (HELLAS) LTD.
110 Syngrou St., Athens, Greece
Tel. 9219082, 9233469

HITACHI SALES (MALAYSIA) SDN, BHD.
17, Jalan 20/16, Petaling Jaya, Selangor, Malaysia
Tel. 762523, 769918, 769836, 762594

HITACHI (SINGAPORE) PTE., LTD.
Room B, C & D, 15th Floor, Yen San Building
268 Orchard Road, Singapore 9, Singapore
Tel. 7378244, 7379826

HITACHI SALES (THAILAND) LTD.
2242-48, New Petchburi Road, Bangkapi, Hueykuang
Bangkok, Thailand
Tel. 314-2741

HITACHI ELECTRIC SERVICE CO., (HONG KONG) LTD.
4th Floor Leun Tai Industrial Bldg., 72-76 Kwai Cheong
Road Kwai Chung N.T., Hong Kong
Tel. 240126

HITACHI SALES AUSTRALIA PTY LTD.
153 Keys Road, Moorabbin, Victoria 3189 Australia
Tel. 555-8722

HITACHI SALES CORPORATION OF AMERICA
Eastern Regional Office
1290 Wall Street West, Lyndhurst, New Jersey 07071,
U.S.A.
Tel. 201-935-8980

Mid-Western Regional Office
1400 Morse Ave., Elk Grove Village, Ill. 60007, U.S.A.
Tel. 312-593-1550

Southern Regional Office
510 Plaza Drive, College Park, Georgia 30349, U.S.A.
Tel. 404-763-0360

Western Regional Office
401 West Artesia Boulevard, Compton, California 90220
U.S.A.
Tel. 213-537-8383

HITACHI SALES CORPORATION OF HAWAII, INC.
3219 Koapaka Street, Honolulu, Hawaii 96819, U.S.A.
Tel. 808-836-3621

HITACHI (HSC) CANADA INC.
3300 Trans-Canada Highway, Pointe Claire, Quebec,
H9R 1B1, Canada
Tel. 514-697-9150

Hitachi Sales Centroamericana, S.A.
San Rafael de Escazu, (Apartado 10272), San Jose,
Costa Rica
Tel. 28-20-11, 28-00-37

Hitachi Sales Corporation de Panama, S.A.
Nuevo Reparto E1 Carmen, Calle Ramon Arias y Calle B
Edificio Brasil 100, (Apartado 7657) Panama 5
Panama City, Rep. of Panama
Tel. 61-3100, 61-4305

Hitachi Sales de Chile Cia., Ltda.
Av. Mexico, 0183, Casilla 9793, Correo Central
Santiago, Chile
Tel. 774165

HITACHI-FRANCE S.A.
95-101 Rue Charles Michels,
93200 SAINT-DENIS,
France
Tel. 1-4821-6015

HITACHI LTD. TOKYO JAPAN
Head Office: THE HITACHI ATAGO BLDG.
No. 15-12, 2-Chome Nishi-Shinbashi
Minato-ku, Tokyo 105, Japan
Tel. Tokyo (03) 502-2111

HTA-D50/D30 TY No. 505 EGF